



UNIDEX UX24

standalone & IP mixer console

OWNER'S MANUAL



UNIDEX ADAPTERS

Contents

SECTION 1 OVERVIEW.....	5
1.1 The concept behind UNIDEX.....	5
1.2 Features overview.....	5
1.2.1 Channels.....	5
1.2.2 Inputs.....	5
1.2.3 Outputs.....	6
1.2.4 Monitoring and intercoms.....	6
1.2.5 GPIO.....	6
1.2.6 StudioBox (optional).....	6
1.3 Technical support and upgrades.....	6
SECTION 2 CONNECTIONS.....	7
2.1 Power on/off and resets.....	7
2.1.1 Power source.....	7
2.1.2 Grounding.....	7
2.1.3 CPU Power off.....	7
2.1.4 System actions.....	7
2.2 Why RJ45?.....	7
2.2.1 Pre-assembled cable kits.....	7
2.3 Rear panel.....	8
2.3.1 Microphones inputs.....	8
2.3.2 UNIDEX inputs.....	8
2.3.3 Balanced analogue inputs.....	8
2.3.4 AES3 digital inputs.....	9
2.3.5 Tuner input (ON AIR).....	9
2.3.6 PROGRAM outputs.....	9
2.3.7 Analog outputs.....	9
2.3.8 AES3 digital outputs.....	9
2.3.9 USB AUDIO I/O.....	9
2.3.10 DANTE – AES67 (optional).....	10
2.3.11 Streaming.....	10
2.3.12 WEB remote interface.....	10
2.3.13 Monitoring at the Studio.....	10
2.3.14 Monitoring in the Control Room.....	11
2.3.15 Tally light.....	11
2.4 GPIO.....	11
2.9.1 Signals at the GPIO connector.....	11
2.9.2 Configure the GPIO actions.....	12
2.9.3 Connecting mic arms with LEDs (GPO).....	12
2.4.4 Cough button (GPI).....	12
2.5 About the connectors and wiring.....	12
2.5.1 Wiring kits.....	12
2.5.2 RJ45 nomenclature.....	13
2.5.3 RJ45 inputs and outputs.....	13
2.5.4 Solidyne UX24 wiring kits.....	13
2.5.4.1 To RCA (unbalanced).....	13
2.5.4.2 To balanced XLR.....	13
2.5.4.3 To balanced TRS.....	13
SECTION 3 UNIDEX EXTERNAL ADAPTERS.....	15
3.1 Concept.....	15
3.2 UDX 2MIC.....	15
3.2.1 Setting up.....	15
3.2.2 Inputs settings.....	15
3.2.3 Channel configuration.....	16
3.3 UDX 2TEL and 2TEL-P.....	16
3.3.1 Connecting UDX 2TEL/2TEL-P.....	16
3.3.1.1 Connection to phone lines.....	17
3.3.2 Inputs settings.....	17
3.3.3 Outputs settings.....	18
3.3.4 Channel settings.....	18
3.3.5 ADJUSTING THE REJECT FACTOR.....	18
3.4 UDX TEL+BT.....	19
3.5 UDX USB.....	19
3.5.1 Input setup.....	19
3.5.2 Output setup.....	19
3.5.3 Channel settings.....	20
3.6 StudioBox HD3 & HD5: monitoring into the Studio.....	20
3.6.1 CONNECTING.....	20
3.6.2 USING THE STUDIOBOX.....	21
SECTION 4 START UP AND ROUTING.....	23

4.1 Starting up	23
4.2 Inputs/outputs default routing	23
4.2.1 Default inputs routing.....	23
4.2.2 Default outputs routing.....	23
4.2.3 Users and access restrictions.....	23
4.3 SETTINGS	24
4.4 SETTINGS: INPUTS	24
2 AUDIO INPUTS.....	24
3 GAIN.....	24
4 INPUT FEATURES.....	24
4.5 SETTINGS: OUTPUTS	24
1 – OUTPUT LIST.....	25
2 – OUTPUT GAIN.....	25
3 AUDIO MODE.....	25
4 INTERCOM.....	25
5 STUDIO B SPEAKERS.....	25
6 SOURCE.....	25
4.5.1 MIX MINUS.....	25
7 SEND MODE.....	25
4.6 SYS CONFIG	25
1 CHANNEL ON-AIR ON STARTING.....	26
2 NETWORK SETTINGS (Ethernet control).....	26
3 CLOCK SETTINGS.....	26
4.7 Streaming	26
4.7.1 Streaming signal and send level.....	26
4.7.2 UP-STREAM (TX).....	26
4.7.2.1 ICECAST/SHOUTCAST STREAM.....	26
4.7.3 RTP STREAM.....	27
4.7.4 DOWN-STREAM (RX).....	27
4.7.5 STREAMING NETWORK.....	27
4.8 GPIO	27
4.9 SETTINGS: USERS	28
4.10 AoIP	28
SECTION 5 OPERATION	29
5.1 Overview	29
5.2 Main screen	29
5.3 Channels	30
5.4 Monitoring section	31
5.4.1 Screen MONITOR.....	32
5.5 THE FUNCTION SELECT	33
5.6 THE SCREEN “CHANNEL”	33
5.7 TELCO - COMMUNICATIONS	35
5.7.1 NULL ADJUST.....	36
5.7.2 BLUETOOTH PAIR.....	36
5.8 WORKING WITH CALLS	36
5.8.1 Incoming call.....	36
5.8.2 Make a call from console.....	36
5.9 AUDIO PROCESSORS	37
5.9.1 PARAMETRIC EQUALIZER.....	37
5.9.1.1 LOW-PASS/HI-PASS FILTERS.....	38
5.9.2 DYNAMICS.....	38
5.9.3 DE-ESSER.....	38
5.10 Scenes and user profiles	39
5.11 VIRTUAL MIXER	40
SECTION 6 WEB REMOTE INTERFACE	41
6.1 Connecting to LAN	41
6.2 WEB USER	41
6.3 REMOTE CONTROL	41
6.3.1 Settings.....	42
6.3.2 Mic and line channels.....	42
6.3.3 TELCO channels.....	42
6.4 PROCESS	43
SECTION 7 DIAGRAMS AND TECH NOTES	44
Diagrams.....	44
Quick installation guides.....	44
Cables and kits for the installing.....	44
SECTION 8 TECH SPECS	45

SECTION 1 OVERVIEW

USER MANUAL REVISION: May 2022

1.1 The concept behind UNIDEX

The Solidyne UNIDEX mixing consoles were designed to meet the needs of a wide range of radio stations.

The guiding idea was to reach a compact digital console, that joint all technologies with a great flexibility of connection and configuration, including audio over network (DANTE/AES67). And it must be a "standalone" unit, that is, the control surface and the mix engine should be contained in one framework.

Simple adapters for simple installations

UNIDEX stands for UNIversal Desktop with EXternal adapters. The UNIDEX inputs allow you to connect external adapters (UDX) to handle telecommunications, microphones or USB interfaces among others. UDX adapters connect directly to the console. No routers, switches or networks are required. The UNIDEX inputs have a data channel that controls functions of Solidyne UDX adapters.

Audio over IP for more advanced installations

DANTE/AES67 connectivity allows to set up studios far from the console, using an audio network. This implementation requires to set up a dedicated network, and DANTE I/O interfaces to send signals to the network (microphones) and receive signals (monitoring). DANTE module replaces 8 stereo inputs by 16 AoIP inputs, and coexist with the others inputs and outputs of the console. The operator controls remotely the UX24 using a computer to access the console's WEB interface. DANTE connectivity is optional.

DANTE connectivity is optional. When the UX24 does not have DANTE, the 8-IN module is included, with 8 balanced stereo inputs (4 of the UNIDEX type).

Solidyne UNIDEX UX24 is a standalone unit, containing a fully digital mix engine. It works at 24 bits @ 48 kHz with DSP processing. Its rear panel presents 4 microphone inputs, 20 stereo inputs and 24 outputs. The number of inputs is greater when used in mono for microphones and communications. UX24 has 12 faders, and can manage another 12 "virtual faders" from a touch screen on board. Everything can also be managed from an external tablet or computer. As an option, up to two panels (hardware) of 6 faders can be added, to obtain a total of 24 real faders.

Its compact profile presents all the inputs and outputs on the rear panel, with RJ45. Solidyne provides "RJ45 to audio-connector" patch cords (XLR, TRS, RCA).

The startup is simple. UX24 connects and go on-air with few previous settings. No advanced knowledge is required. In general, the operation of the console does not differ from a conventional console. Some features, such audio processors, are operated from the on board touch screen.

There are **3 users profiles** that gives access control. A basic operator can access only the minimum functions; but a senior operator can use advanced features or have full access to features and settings.

UX24 flexibility:

- Inputs can be assigned to any of the 12 physical faders, or the 12 "virtual" faders.
- It is possible to create scenes with different channel settings or different processing settings (i.e. for microphones).
- Remote access using a web interface.
- Manage up to 2 Studios.
- VST real time effects via USB ASIO and the external computer.

All features and settings can be accessed from the touch screen, or via IP with a computer using a WEB browser.

1.2 Features overview

1.2.1 Channels

- The UNIDEX UX24 mix engine manages 24 channels: 12 channels with 100 mm faders; and 12 "virtual" channels commanded from the surface screen or remotely via web interface. The number of faders can be expanded with 6-channel UX6 modules, to have frameworks with 18 or 24 hardware channels.
- Each channel can receive audio from any input (except from the *external tuner*).
- The channels can work in 3 modes: **MIC**; **LINE**; **TELCO**. These modes changes functions and the behavior of the channel and sets according to the input.
- Channels can be assigned to 4 stereo mix buses: **PGM**, **REC**, **AUX**, **VBUS**.

1.2.2 Inputs

- **4 balanced for mics** (mono), phantom powered (48V). They have 4 band parametric EQ, dynamic compression, noise gate and de-esser.
- **4 balanced stereo**: With 3 bands parametric EQ.
- **16 UNIDEX** (8 stereo): 16 balanced mono inputs with POE and data channel. They can be used with the UNIDEX adapters to connect microphones, telephone lines, bluetooth interfaces and other sources. Can be coupled in stereo pairs. They have 3-band parametric equalizer, dynamic compression and noise gate.
- **4 USB** (stereo): The computer connected by USB to the UX24 has four USB playback de-

vices. Supports ASIO 3.0 These inputs have a 3-band parametric equalizer.

- **4 AES-3** (stereo): These inputs have a 3-band parametric equalizer.
- **1 incoming streaming** (it is not an input itself because when activated it replaces the AES-3 # 1 input).
- 1 input for **external tuner**, used to monitor the transmission on-air.

1.2.3 Outputs

UNIDEX UX24 has 18 stereo outputs and 4 outputs for monitoring:

- **2 Program** (dual): Two PGM analogical balanced outputs.
- **4 balanced stereo** (assignable).
- **4 unbalanced stereo** (assignable) It can be set as mono with mix-minus to be used with phone hybrids and VoIP.
- **4 USB stereo sends** (assignable). It are recognized in Windows as *Solidyne USB input devices*.
- **4 AES3** (two assignables).
- **Dual streaming** PCM/MP3 (RTP + Icecast/ Shoucast *upstream*).

1.2.4 Monitoring and intercoms

- 2 outputs for studio monitors (loudspeakers + headphones).
- 2 outputs for control room monitors (loudspeakers + headphones)
- Talk-back to studio.
- 4 Intercom lines assignable to outputs.
- CUE bus (PFL) assignable to outputs.

1.2.5 GPIO

The console has 4 GPI and 8 GPO, "Open collector". GPIO allows to command the Audicom software, digital audio processors or any other device equipped with remote control. Activation is programmable (see below).

1.2.6 StudioBox (optional)

The Solidyne StudioBox HD3 and HD5 accessories (optional) contains in a box all the monitoring connections needed into the Studio.



Features:

- Connection for 5 headphones in HD5 with independent controls of level (3 headphones in HD3 models).
- Double listening channel.
- Output for powered monitor speakers, with a level control.
- Tally light.
- Reverse talk-back, to speak from the Studio with the operator at CR (no matter the status of CUE in the microphone channels).
- Timer/Clock (only for HD5)

For details please refers to 3.6 - StudioBox HD3 & HD5

1.3 Technical support and upgrades

For specialized support and upgrades please contact to Solidyne SRL:

info@solidyne.ar

+54911 3119 3254 (only Whatsapp)

For video tutorials and user's guides visit:

www.youtube.com/SOLIDYNEbroadcast

Diagrams, technical papers and application notes are available online in www.solidyne.ar/unidex (see details in Section 7 of this manual).

SECTION 2 CONNECTIONS

2.1 Power on/off and resets

2.1.1 Power source

The unit has an internal switching power supply, 110/240V 50/60Hz.

At the rear panel locates the main power switch; a general fuse (1A) and the outlet for the AC power cord (Interlock type) which is supplied from factory.

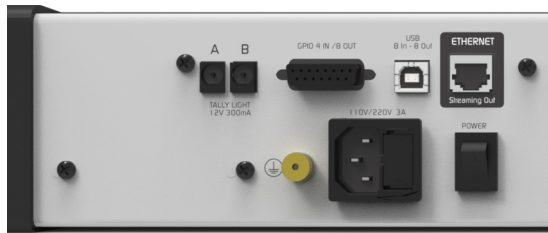

Figure 1: Rear panel – AC male Interlok and main switch

2.1.2 Grounding

UX24 is grounded through the power cord. Do not use adapters or cables that suppress the grounding pin.

It is also recommended to connect the chassis grounding terminal to the installation grounding, using cable with section 4 mm or higer.

The general electrical installation must be properly grounded. As reference, in Section 7 - DIAGRAMS AND APPENDICES you will find a grounding installation diagram for an FM station.

ATTENTION!

Make sure that the computer connected to UX24 via USB have a proper grounding.

2.1.3 CPU Power off

UX24 has an internal CPU. Before switch off the unit, is strongly recommended power off the CPU from the touch screen. The STATUS EXTRA option locates in STATUS area. Touch on “+” icon to access. A pop up window will appear. Touch on the option POWER-OFF to turn off the internal computer.

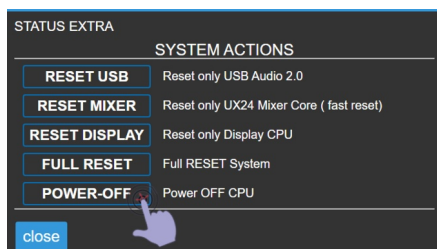
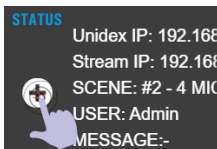

This action will not turn off the hardware. The full turn-off is done with the mechanical on/off switch. Once the CPU shut down, wait a few seconds before turning off the power switch.

2.1.4 System actions

These options allows to reset different stages of the mixer console. They are not used by the operator, but they can be needed in some cases for software/firmware updates.

RESET USB: Reset only the USB stage, forcing the operating system to recognize the device again.

RESET MIXER: Reset the mixing engine and the control surface.

RESET DISPLAY: Reset the computer, which manages the visual interface and the streaming.

FULL RESET: Full-reset of UX24 (is equivalent to turning off the unit).

2.2 Why RJ45?

UNIDEX series come with inputs and outputs full connectorized with **RJ45**. And must be wired using **CAT-5 shielded multipair cable (STP)**. With the advent of audio over IP (AoIP), several manufacturers began using RJ45 connectors and shielded multi-pair cable to replace the different audio connectors, standardizing the entire installation with a single type of connector and the same type of cable. The use of these connectors also allowed to considerably reduce the size of the consoles.

The use of structured cable facilitates installation anywhere in the world due to the availability of components and assembly tools used in data networks. At the end of the multipair cable the connection to an audio equipment (microphones, speakers, players, audio interfaces) will still require some type of conventional audio connector. For that, there are female RJ-45 patch cords to adapt to the audio connector needed.

2.2.1 Pre-assembled cable kits

Solidyne provides (optionally) kits of cables and adapters; intended to install the console without welding. For new installations, there are full cable kits. For replace an old console maintaining some of the existing wiring, there are adapters patch cords. The user can also build a custom kit by choosing each cable according to his needs.

The following links details all available options:

<http://www.solidynepro.com/consola-de-audio-de-bc-acesorios-y-cables/>

[List of cables and adapters patch cords \(PDF\)](#)

2.3 Rear panel

The rear panel contains all the inputs and outputs. All audio connectors are RJ45, with the exception of control room outs for headphone and speaker.

The inputs can be assigned to any of the 24 channels, physical or virtual. Please see the SECTION 4, Start Up and Routing for details.

The mixer console has 12 default scenes with basic configurations that, in most cases, allows to starting to work without major settings changes.

Check the SECTION 7 section on this manual and download an infographic (PDF) that summarizes the interconnection flexibility of the UNIDEX UX24.



A 4 MIC INPUTS	F 4 BAL & 4 UNBAL ST OUTPUTS	K 4 IN/4 OUT STEREO USB
B 16 UNIDEX INPUTS (8 STEREO)	G 2 PGM OUTPUTS	L 16x16 DANTE/AES67 REPLACING 8 STEREO ANALOG INPUTS (UNIDEX 5, 6, 7, 8 and 4 STEREO BAL)
C 4 STEREO BALANCED INPUTS	H ETHERNET (AUDIO STREAMING)	■ INPUTS
D 4 AES3 STEREO INPUTS	I ETHERNET (REMOTE CONTROL)	■ OUTPUTS ■ UNIDEX INPUTS
E 4 AES3 STEREO OUTPUTS	J HD3/HD5 STUDIO MONITOR DOCK	■ ETHERNET ■ SOLIDYNE HD3/HD5

Figure 2: i/o connectors

2.3.1 Microphones inputs

A UX-24 has four microphone inputs, electronically balanced. All inputs gives switchable 48V phantom power. Each input uses an RJ45 female connector that connects using a SOL-M25/1XLR cable.

4 dip-switch allows the user to attenuate the preamplifiers gain by -12dB (moving the switch down reduces the gain).

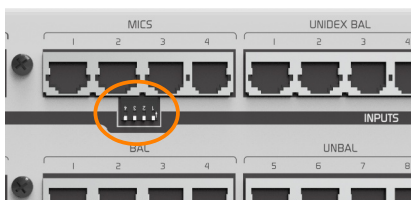

Figure 3: MIC gain attenuation

MODELS WITH DANTE (UX24-A67)

When UX24 includes the DANTE/AES67 option (UX24-A67) the inputs UNIDEX 5, 6, 7 and 8 are not available. Internally they become AoIP inputs 1, 2, 3 and 4.

The UDX adapters connects to the UNIDEX inputs via RJ45 to RJ45 patch cords (SOL-P25 or SOL-P50). There are different UDX adapters:

- POTS [UDX 2TEL and UDX 2TEL-P adapters]
- Smartphones via Bluetooth [UDX TEL+BT]
- Microphones: Dynamic and phantom powered condenser [UDX 2MIC]
- Dynamic microphones [UDX DMIC]
- Computers via USB → AES3

UNIDEX inputs can be used as conventional line level balanced inputs.

Each UNIDEX RJ45 contains two channels; left and right if stereo. In this case the connection is made using adapter cables by Solidyne (or others brands like StudioHub^(c), by AngryAudio).

NOTE

The RJ-45 pin out is compatible with balanced stereo patch cords RJ45 to XLR (SOL-M12/XLR y SOL-M25/XLR). Mic inputs uses only the LEFT channel.

2.3.2 UNIDEX inputs

B UNIDEX inputs -a proprietary Solidyne development- are enhanced inputs that manages audio and other signals (POE and communication) to control the Solidyne UDX external adapters.

There are **16 mono inputs**, which can be grouped into stereo pairs (8 stereo). For the technical specifications UNIDEX inputs counts as mono inputs because they are usually used to connect mono sources as microphones, phone lines and mobile phones.

2.3.3 Balanced analogue inputs

C 4 balanced stereo inputs. Each input uses one RJ45, since STP cable can carries both left and right balanced signals. At the end of the cable, the RJ45 is converted to an audio connector.

To connect an input in unbalanced mode, an adapter cable is used - the signal terminals (-) are connected to the cable shield, and the (+) terminal to the 'live'. See 2.5 - Connectors and wiring.

MODELS WITH DANTE (UX24-A67)

When UX24 includes the DANTE/AES67 option (UX24-A67) the balanced inputs 9, 10, 11 and 12 are not available. Internally they become AoIP inputs 5, 6, 7 and 8.

2.3.4 AES3 digital inputs

D There are 4 AES3 digital stereo inputs. Each input uses an RJ45 connector, which will be connected with RJ45-RJ45 CAT5 cable and SOL-F3/XLRF adapter. For cable compatibility, use the same pinout of the stereo balanced inputs, but only the left channel is connected. They also support connection of S-PDIF.

2.3.5 Tuner input (ON AIR)

Stereo input that allows to enter the audio from an **external receiver**. It uses a 1/4 "JACK TRS connector.

2.3.6 PROGRAM outputs

G Both RJ45 labeled as PGM are analog balanced outputs. The bus PGM is internally routed to this outputs (fixed routing).

2.3.7 Analog outputs

F UNIDEX UX24 have 8 stereo analog outputs:

- 4 balanced (electronically),
- 4 unbalanced.

Each output uses one RJ45 with left and right signals.

The user can change the signal assigned to each output. For some applications, stereo outputs can be used as two independent channels. UDX adapters for telephone lines, for example, use mono unbalanced outputs to send signals to telephone lines.

2.3.8 AES3 digital outputs

E 4 stereo AES3 outputs, SPDIF compatible. Each output uses one RJ45 connector (balanced).

AES3 connects using one RJ45-RJ45 CAT5 and a patch cord adapter SOL-F3/XLRM. It uses the same pinout that the balanced stereo outputs, but using only the left channel.

The outputs AES3-1 and AES3-2 sends buses PGM and REC respectively. AES3-3 and AES3-4 signals can be assigned by the user from SETTINGS → OUTPUTS.

2.3.9 USB AUDIO I/O

K On-board USB provides 4 stereo input channels or "stereo playback devices" at the computer side; and 4 stereo output channels or "stereo recording devices" at the computer side.

The signals send to the computer via USB are routing from the screen SETTINGS → OUTPUTS.

TAKE IN MIND

While the USB is a data port, we refers to it as *the USB audio outputs and inputs*. As with all traditional audio connections, the "USB outputs" of the console are connected to "USB inputs" on the computer.

NOTE

The following description refers to the on-board USB. To install an external adapter **UDX USB** please see 2.11 – UNIDEX external adapters

The USB connection requires a computer with Windows © 10. Provides four stereo playback devices and four stereo recording devices. Requires the installation of own driver. To install follow the next steps:

1. Connect the USB port of UX24 to a USB port of the computer, using the USB A-B cable supplied with the console.

WARNING

The use of damaged or poor quality cables may cause the computer not to properly recognize the USB device.

2. Download the driver from the following link:
http://solidynePRO.com/DW/Solidyne_UsbAudio.zip
3. Run the setup and follows the instructions.

Once installed, Windows shows four Solidyne USB output devices, and four Solidyne USB input devices.

The **Solidyne USB-OUT devices** (fig.3) in UX24 correspond to the inputs: USB-1; USB-2; USB-3 and USB-4.

The **Solidyne USB-IN devices** (fig.4) in UX24 correspond to the outputs USB-1 to USB-4, which can be assigned to the buses (PGM, REC, AUX and VBUS) among other possible signals (see SETTINGS → OUTPUTS).

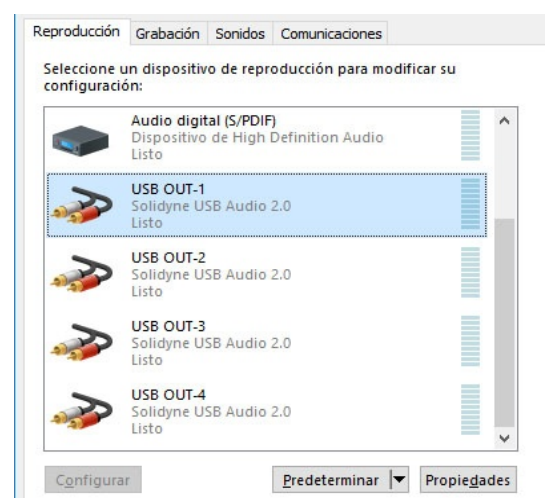

Figure 4: Windows USB output devices

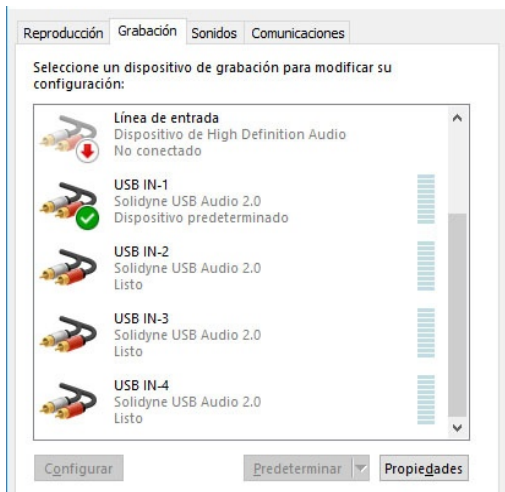

Figure 5: Windows USB inputs devices

UX24 supports ASIO 3.0, allowing simultaneous shared playback between different software applications. For example, while air management software plays music over a USB channel, other software takes a USB send from the console to add effects to the microphones in real time, using VST plug-ins.

2.3.10 DANTE – AES67 (optional)

L DANTE module (only models UX24/A67). Brings 16 inputs and 16 outputs over network.

DANTE INPUTS

The 16 AoIP DANTE inputs **replaces** to the inputs UNIDEX 5, 6, 7 and 8 (stereo); and the stereo balanced inputs 9, 10, 11 and 12.

DANTE OUTPUTS

DANTE gives 16 outputs over the network. 10 of this takes the signal from certain UX24 outputs and 6 are only AoIP outputs.

UX24 STANDARD OUTPUT	DANTE OUTPUT
PGM-L	AoIP 1 (L)
PGM-R	AoIP 2 (R)
OUT1-L	AoIP 3 (L)
OUT1-R	AoIP 4 (R)
OUT2-L	AoIP 5 (L)
OUT2-R	AoIP 6 (R)
STUDIO HEADPHONES L	AoIP 7 (L)
STUDIO HEADPHONES R	AoIP 8 (R)
STUDIO SPEAKERS L	AoIP 9 (L)
STUDIO SPEAKERS R	AoIP 10 (R)
-	AoIP 11
-	AoIP 12
-	AoIP 13
-	AoIP 14
-	AoIP 15
-	AoIP 16

2.3.11 Streaming

H Ethernet port for streaming. UX24 can generate two differentiated audio streams, and can decode one incoming streaming.

A streaming uses the RTP protocol and is commonly used to link to the transmitting plant (STL). The second streaming is for upload to Shoutcast/Icecast servers.

Incoming streaming can be RTP or public http streaming. When the incoming streaming option is enabled, the decoded audio is automatically switched to (replaces) the AES-1 input, and changes its name to STREAM-1

The audio streaming is done using the ETHERNET Streaming Out port.



1. Connect "Streaming Out" to the LAN router.
2. The router will assign an IP address to the UX24 streaming module (DHCP). The IP address shows at the main screen as "Stream IP".



3. The configuration of the streaming services can be done from the touch screen, or using a network terminal and a WEB browser and entering the Stream IP address.

2.3.12 WEB remote interface

I Ethernet connector for remote control. It connects to the LAN to access the web control interface using a computer on the network. By default works in DHCP mode. The assigned IP is displayed on the main screen as UNIDEX IP.

2.3.13 Monitoring at the Studio

J STUDIO MONITOR is the connector to the accessories Solidyne StudioBox HD3/HD5 (optional). It gives the signals for monitoring into the Studio A.

Solidyne StudioBox HD3 and HD5 monitoring boxes manages up to five headphones (HD5) and monitor speakers,

among other features (please see “3.5 - Studiobox HD3 and HD5”).

It connects with a shielded multipair STP RJ45 to RJ45, flat pin-to-pin connection.

To use conventional headphones distributors/amplifier, an adapter patch cord is included with the UX24.

WARNING

ONLY THE “STUDIO MONITOR” ADAPTER PATCH CORD PROVIDED WITH THE UNIT can be used when the Solidyne StudioBox is not available.

DO NOT CONNECT THE **STUDIO MONITOR OUTPUT** USING RJ45 FOR OTHER AUDIO OUTPUTS.

Example using a standard headphones amplifier.

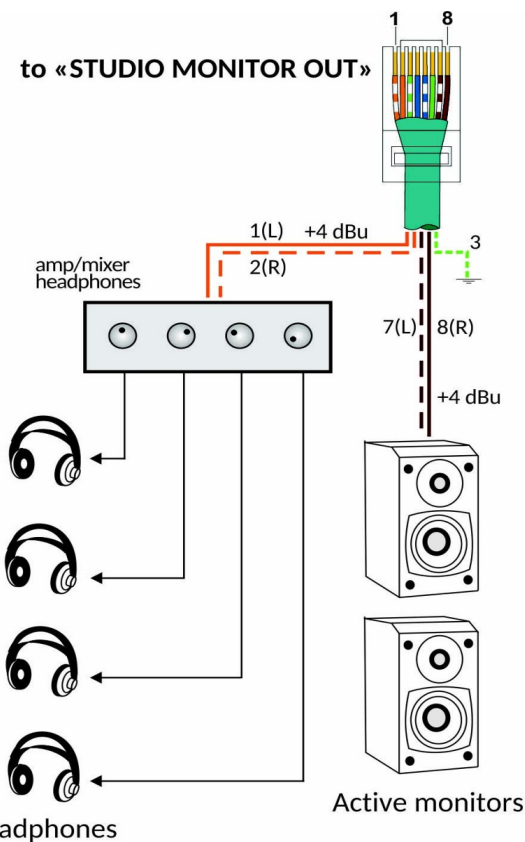

Figure 6 - Connections for monitor speakers and headphones at the Studio, using the adapter patch cord and a standard headphones amplifier.

The STUDIO MONITOR pinout is the follow:

RJ-45	STUDIO MONITOR OUT
1	Headphones, left (+4 dBu)
2	Headphones, right
3	GND
4	ON-AIR (+14 V)
5	Talckback to Control Room
6	VCC + 14 V
7	Speakers, left (+4 dBu)
8	Speakers, right

*Chassis = GND

2.3.14 Monitoring in the Control Room

In the radio stations that work with the Control Room, the technical operator's headphones are connected directly to the rear panel of the console, in the “CONTROL ROOM” sector. The connector is 1/4” TRS. The monitor speakers of the Control room are connected to the SPK 1/8” jack. It is a line level output.

2.3.15 Tally light

There are two outputs for “On Air” signaling lights; one for Studio A and another one for the Studio B. Each output gives 12VDC / 250mA. This outputs supports direct connections of LED sets. 2 Solidyne LA200 tally-light can be connected on each output. For other models, make sure that the consumption do not overpass 250 mA.

The GPO-8 output also delivers 12V / 250mA and can be programmed to operate with any of the Tally Light outputs.

Optionally, GPO outputs 1 to 7 can be used to control individual on-air lights microphone arms. These GPO are of the “open dry” type (they switch between open circuit or ground) therefore they require an external power supply and, depending on consumption, a switching circuit (see next).

WARNING

The outputs for tally lights are protected by a PTC or fusistor, which operates by over-heating when the current exceeds 250 mA; cutting the voltage at the output.

To restore the voltage, disconnect the load (tally light) and check the cause of over-consumption (excessive consumption or a short circuit).

2.4 GPIO

The **GPIO** (General Purpose Input/Output) connector offers 4 inputs and 8 outputs. The GPIs allows to command some UX24 features like mics activation. GPOs can trigger external devices, such as “on-air” signaling lights; the Solidyne Audicom software or the audio processor.

- The 4 **GPI** supports trigger signals from 5 to 15V / 150mA (active high).
- **GPO 1 to 7** are “open drain”, supporting signals from 5 to 24 V / 250 mA.
- **GPO 8** gives 12V/250 mA (active high). It can manage a relay.

2.9.1 Signals at the GPIO connector

The GPIO connector is a **female DB15** located at rear panel. The pin-out is the following:

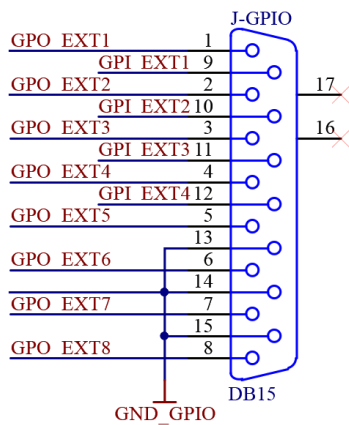

2.9.2 Configure the GPIO actions

The actions that manages the GPIO are configured in the screen SETTINGS → GPIO. Please refers to **4.8 - GPIO settings**.

2.9.3 Connecting mic arms with LEDs (GPO)

GPOs 1 to 7 can work as electronic switches managing LEDs directly connected to an external power supply. The consumption must not exceed 250mA.

The following figure shows an example of direct connection of a microphone arm with LED light, using GPO 1.

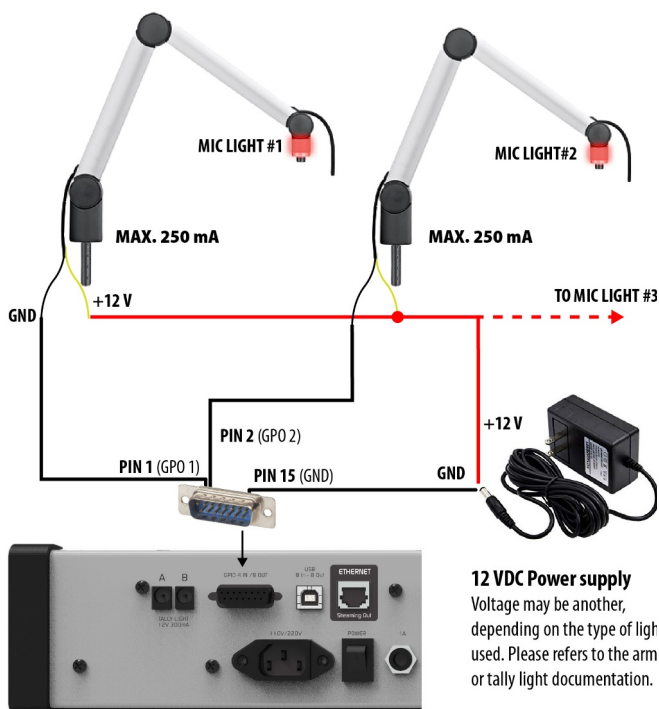

For currents greater than 250 mA, relays must be used for switching. Note that GP8 can be used to directly handle a coil relay of 12V / 250 mA maximum current.

In the example, the GPO are set to be active with the MIC channel on/off status (GPO1 → ON/OFF Channel MIC-1; GPO2 → ON/OFF Channel MIC-2; etc).

2.4.4 Cough button (GPI)

One action that GPI can manage is CHANNEL MUTING. This feature can be used to install a *cough button* into the Studio, in order to the talent/speaker can temporarily mute their microphone.

The following example shows the connection of a push button switch to enable the GPI 1.

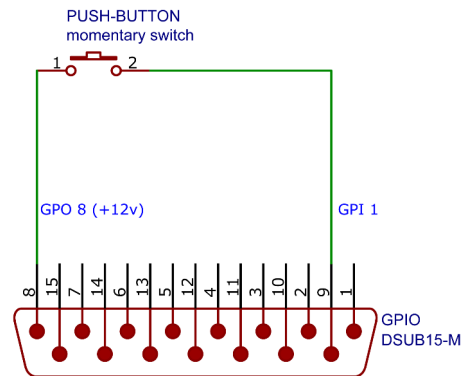

In GPIO settings, the GPO 8 is fixed to 12V and GPI 1 is set to MUTE action, linked with the mic channel that corresponds.

While the channel is muted, the operator can retake the control by moving the fader.

2.5 About the connectors and wiring

2.5.1 Wiring kits

Solidyne can provide all cables and adapters patch cords needed to the installation. See the following links for details.

<http://www.solidynepro.com/consola-de-audio-de-bc-accesorios-y-cables/>

[Cables and audio adapters \(PDF\)](#)

Other cables such as the well-known "StudioHub"(c) can be used on all audio inputs/outputs; **with the exception of the output of STUDIO MONITOR** that uses a particular cable supplied by Solidyne.

If you choose to assemble the cables, use shielded RJ45 connectors and good quality STP or FTP CAT5 cable. Be sure to attach the connector shield to the cable shield.

Prevent cables from hanging on their connectors. Use cable ducts to distribute the cables.

Avoid joining audio cables with AC power cables. Use separate paths for each case.

If there is some background humming and the ground connections are well made; it may be due to RF standing waves introduced by the FM antenna. In that case, ferrite rings can be placed on all cables.

2.5.2 RJ45 nomenclature

The following table shows the color nomenclature and standard pin numbering of an RJ45 connector.

RJ45 NOMENCLATURE	
PIN	WIRE COLOR
1	Orange/White
2	Orange
3	Green/White
4	Blue
5	Blue/White
6	Green
7	Brown/White
8	Brown

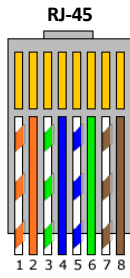

2.5.3 RJ45 inputs and outputs

The following table shows the color nomenclature and standard pin numbering of an RJ45 connector.

NOTE

The "SOL-M12 /minijack" adapters (1/8 female TRS) can be connected to **balanced or unbalanced outputs**. It is not recommended to unbalance inputs, since leaving the (-) signal unconnected can pick up noise.

The "SOL-M12 /RCAM" adapters (to RCA male) can be connected to **balanced INPUTS** to unbalance them, since they connect the balanced (-) signal to ground. **DO NOT USE ON BALANCED OUTPUTS.**

BALANCED INPUTS / OUTPUTS

PIN	WIRE COLOR
1 Left channel (+)	Orange/White
2 Left channel (-)	Orange
3 Right channel (+)	Green/White
4 Ground	Blue
5 Reserved	Blue/White
6 Right channel (-)	Green
7 -15 (option)	Brown/White
8 +15 (option)	Brown

UNBALANCED INPUTS / OUTPUTS

PIN	WIRE COLOR
1 Left channel (+)	Orange/White
2 NC	Orange
3 Right channel (+)	Verde/White
4 Ground	Blue
5 Reserved	Blue/White
6 NC	Green
7 -15 (option)	Brown/White
8 +15 (option)	Brown

2.5.4 Solidyne UX24 wiring kits

All RJ45 adaptation sections (male or female) to standard audio connectors can be ordered from the factory. Check the **complete listing of cables** in the following link:

<http://www.solidynepro.com/consola-de-audio-de-bc-ac-cesorios-y-cables/>

Next figures details the connections between RJ45 and common audio connectors:

2.5.4.1 To RCA (unbalanced)

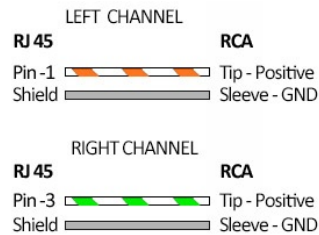

2.5.4.2 To balanced XLR

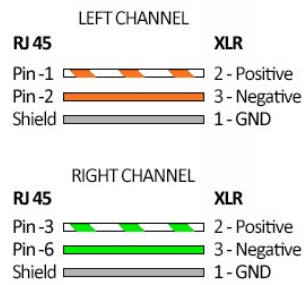

NOTE

The RJ45 microphone inputs in the back panel uses only the left channel or the balanced connection.

Solidyne provides the cables SOL-M25/1XLRf and SOL-M12/1XLRf to connect microphones (single XLR to RJ45).

2.5.4.3 To balanced TRS

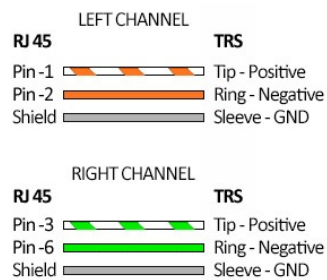

ADVICE!

SOL-M12 / minijack adapters (to female miniplug) can be connected to balanced or unbalanced OUTPUTS. It is not recommended to unbalance inputs since they leave the (-) pin unconnected and can introduce interference.

The SOL-M12 / RCAM adapters (to RCA male) can be connected to balanced INPUTS to unbalance them, since they connect the balanced (-) signal to ground. **DO NOT USE THEM ON BALANCED OUTPUTS**, because the UX24 outputs must be unbalanced leaving the (-) pin unconnected.

SECTION 3 UNIDEX EXTERNAL ADAPTERS

3.1 Concept

UNIDEX external adapters (UDX) allow you to expand the console's ability to manage many types of signals and devices. Each UDX adapter requires point-to-point connection to an UNIDEX input of UX-24, using RJ45 cables. Some UDX adapters also connects to UX24 outputs.

The operator controls the UNIDEX adapters functions from the console surface.

Available UDX adapters are:

- **UDX 2MIC:** Mic preamp of two inputs, 48V phantom powered.
- **UDX DMIC:** Mic preamp for dynamic microphone, built-in into a XLR connector.
- **UDX 2TEL y 2TEL-P:** 2-lines hybrid (POTS).
- **UDX TEL+BT:** Combined Hybrid with one POTS and one bluetooth link for smartphone.
- **UDX USB:** USB to AES-3. Stereo I/O to connect computers to the console.

3.2 UDX 2MIC

UDX 2MIC is a pre-amp for two microphones. It has 48V "phantom" power, switchable from the console control interface.



3.2.1 Setting up

UDX 2MIC is connected to a balanced UNIDEX input, using a single STP RJ45-RJ45 cable (Solidyne SOL-P50 or SOL-P25 cables).

Microphones connects to the UDX adapter using standard XLR.



UDX 2MIC has -10dB pad dip-switches. The switches labeled A and B change the attenuation for inputs A and B respectively (the two central switches are unused).

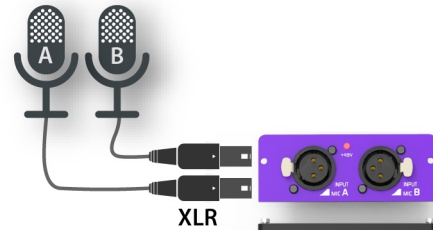

UNIDEX INPUTS
UDX 2MIC connects to one of the 8 UNIDEX inputs. We recommend reserving audio inputs 1 to 4 for UDX TELCO adapters.
In the default 6MIC 2TEL scene input 5 is predefined to connect a UDX 2MIC; and assigned to channels 5 and 6. In this case the user only need to set the phantom power (default on) and gain.



RJ45 STP
(cod. SOL P50)

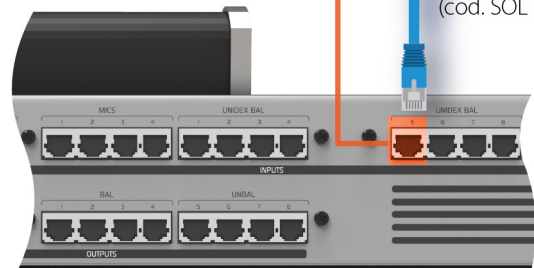

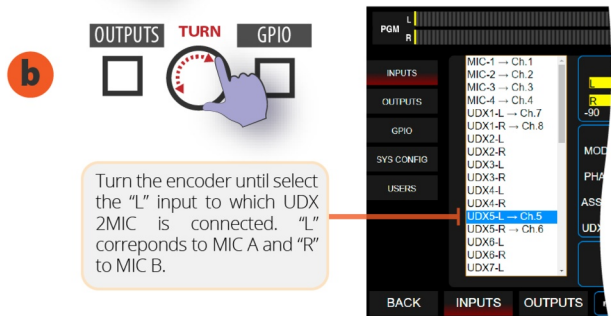
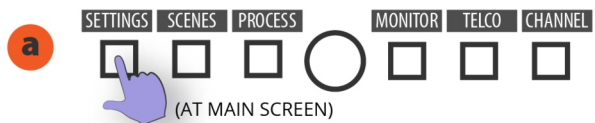

3.2.2 Inputs settings

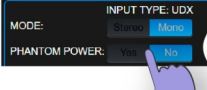

d  Set **UDX TYPE** as **2MIC**.

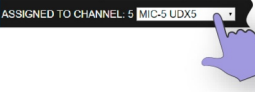
e  If needed, turn on the **48V phantom power**. It enables on both UDX2MIC inputs.

f  Assign the input to one of **CHANNELS**.

g  Press **BACK** to return to main screen.

3.2.3 Channel configuration

a  Press **CHANNEL** on the main screen. All CUE buttons change its status to SELECT.

b  Press **SELECT** on the channel that wants to edit. CUE buttons returns to normal work and the main screen shows the CHANNEL options. To select a virtual channel, turn the encoder and push to confirm.

c  Set **MODE** as **MIC**.

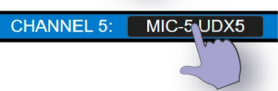
d  To **edit the LABEL**, touch on text. A keyboard will appear.

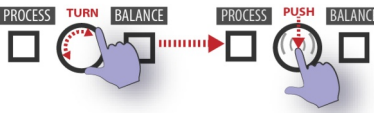
e  Turn the encoder to choose **GAIN**. Push the encoder to edit the value.

f  Set the **GAIN** for peaks reaching **-9dBfs** at the level meter.

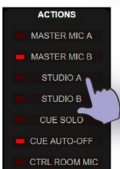
g  Configure the **ACTIONS** for the mic channel. The MIC ACTIONS allows: link the channel to the buttons Master MIC A or B; assign to STUDIO A or B (defines which "On Air" Tally Light will be triggered); set the CUE mode; set as MIC at Control Room (defines which monitors will be muted).

To download a **Quick Installation Guide (pdf)** for this UDX adapter, go to **Section 7 – Diagrams and tech notes**.

REMEMBER

SAVE THE CURRENT SCENE TO STORE THE SETTINGS AND CONFIGURATIONS.

3.3 UDX 2TEL and 2TEL-P

Modules UDX 2TEL and 2TEL-P allows to connect two POTS lines, with their phone sets.



The 2TEL-P model has on board controls that allow to answer calls with a phone set and transfer it to the console. In this way both the UDX and the associated telephones can be located away from the console, for example in a production office.

The 2TEL model has no controls on board. The calls are always answered by the operator from the console surface.

All functions of **UDX-TEL** adapters are operated from the console surface. The operator can dial, answer a call, leave it on hold, dialogue privately and put the call on the air. Each line is handled on individual channels.

3.3.1 Connecting UDX 2TEL/2TEL-P



UDX 2TEL connects to the console using two STP cables with RJ45 at both ends (standard Ethernet shielded cable).

- The output labeled "TO UNIDEX INPUT" connects to an UNIDEX input of the console (inputs UNIDEX 1 to 4).
- The input labeled "FROM UNIDEX OUTPUT" connects to an unbalanced analog output (outputs 5 to 8).

To simplify the connections for UDX-TEL, the UX24 rear panel aligns the UNIDEX inputs 1, 2, 3 and 4 with the unbalanced outputs 5, 6, 7 and 8.

Make the input/output connection as follows:

- Using input UNIDEX 1 and output UNBAL 5
- Using input UNIDEX 2 and output UNBAL 6
- Using input UNIDEX 3 and output UNBAL 7
- Using input UNIDEX 4 and output UNBAL 8

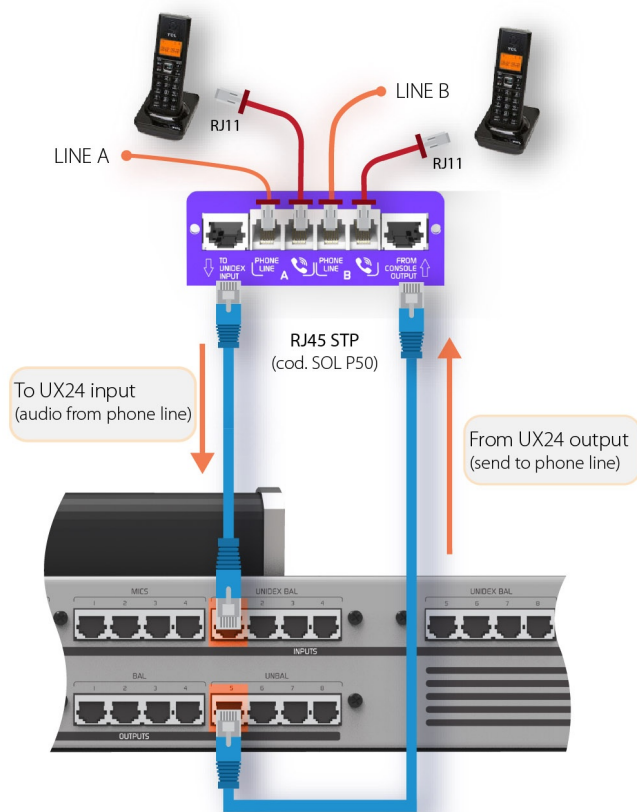

From factory, UX24 have preset scenes for work with UDX 2TEL or 2TEL-P connected to input UNIDEX-1 and to output UNBAL-5.

3.3.1.1 Connection to phone lines

Telephone lines and associated phones are connected using standard RJ11 cables. Two are for connection of telephone lines, and two for their associated telephone devices. The phones work normally while the lines are not taken by the console.

WARNING

If taking a phone line there is **no dial tone**; check if the LINE and PHONE connections are not crossed in the UDX TEL box.

The lines can be connected directly to the public telephone exchange or to a private exchange (PBX). Private exchanges deteriorate the rejection of the hybrid, so we recommend connecting the adapter directly to the public exchange.

The UDX TEL adapters have internal RF rejection filters, both in the medium wave band (AM) and in the VHF and UHF bands, and it is not usually necessary to add any type of additional filter.

Telephone lines are internally protected against high voltage discharges (flashes or non-direct rays) by metal oxide varistors.

To prevent damages caused by voltage spikes, install additional external gaseous protectors over each line (see Section 7 – Grounding Diagram)

WARNING

Is strongly recommended to install additional Lightning/ Surge Protector using Gas Discharge Tube (GDT) protection on each telephone line.

Once UDX-2TEL (or TEL+BT) is connected proceed:

- Configure the inputs and assign channels.
- Configure the outputs.
- Configure the channels.
- Adjust the reject factor at UDX 2TEL.

3.3.2 Inputs settings

a SETTINGS SCENES PROCESS MONITOR TELCO CHANNEL

b OUTPUTS TURN GPIO

Turn the encoder to select the "L" channel at the input to which UDX 2TEL is connected.
UDX-L = Line A
UDX-R = Line B

c INPUT TYPE: UDX
MODE: Mono
PHANTOM POWER: No

Set the **INPUT MODE** as **MONO**.

d UDX TYPE: 2MIC

Change **UDX TYPE** to **2TEL COMPACT**.

e ASSIGNED TO CHANNEL: 5 MIC-5 UDX5

Assigning a **CHANNEL** to the input.

f PROCESS Equalizer Dynamics

Equalization and noise gate can be pre-adjusted.

g REPEAT THE PROCESS FROM ITEM (b) BUT CHOOSING THE CHANNEL RIGHT (UDX-R) TO SET THE **LINE B**

3.3.3 Outputs settings

h 

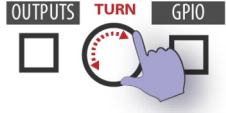
i  Turn the encoder to select the out "L" to which UDX 2TEL is connected.
OUT-L = UDX 2TEL Line A
OUT-R = UDX 2TEL Line B

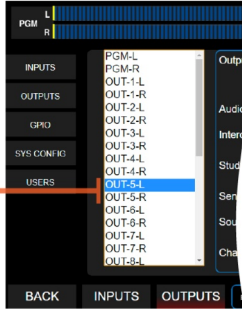

j  Set the output as **MONO**. To change touch the option on screen.

k  Touch to set **Send Mode** as **MIX-MINUS**. This way the output stays associated to the UNIDEX input that corresponds.

l REPEAT FROM ITEM (i) CHOOSING THE CHANNEL "RIGHT" (OUT-R) TO SET THE **LINE B**

m  Press **BACK** to return to the main screen.

3.3.4 Channel settings

a  Press **CHANNEL** at the main screen. All the buttons CUE/SELECT change its status to **SELECT**.

b  Press the button **CUE/SELECT** on the channel that wants to edit. CUE buttons returns to normal work and the main screen shows the **CHANNEL** options. To select a virtual channel, turn the encoder and push to confirm.

c  Set **MODE** as **TELCO**.

d  To **edit the LABEL**, touch on text. A keyboard will appear.

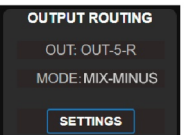
e  Check if the output assignment indicates the corresponding output and if the mode is **MIX-MINUS**.

f  Press **BACK** to return to main screen.

3.3.5 ADJUSTING THE REJECT FACTOR

The rejection factor or "null" factor must be adjusted for each line. Default factory is set to work with ideal line impedances; but in practice the telephone lines do not have the theoretical values, so a fine calibration is necessary.

If the rejection value is not the optimal, when a call is on the air the voice of the Studio announcer can be affected (colored) by the audio of the telephone communication.

The rejection adjustment is necessary in: UDX 2TEL; 2TEL-P and TEL+BT. It is carried out using a precision flat screwdriver, on a preset that is accessed from a hole in the upper face. To make it proceed as follow:

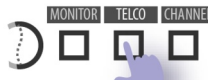
a  Press **TELCO** to access to **TELCO** control panel.

b  **Make a call** (it can be an incoming calling or can be made from console). At the other end the caller must keep silence.

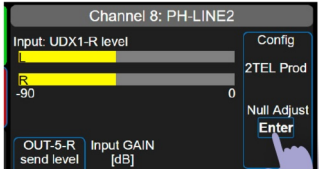
c  In the **TELCO CONFIG** section, press **Null Adjust ENTER**. The console sends a calibration tone to the phone line. The meter **INPUT LEVEL** shows the level at which the calibration signal returns.

d  The operator don't need to put the call on-air to make the calibration (main fader can be closed). The reject factor **adjusts from the UDX 2TEL box** using a knob on a preset, turning in both directions until finding the point where **the calibration signal that returns**, shown on the meter, is **the minimum**.

e  Once settled the reject factor, ends the calling. **The Null adjust must be set for each phone line.**

REMEMBER
SAVE THE CURRENT SCENE TO STORE THE SETTINGS AND CONFIGURATIONS.

To download a **Quick Installation Guide (pdf)** for this UDX adapter, go to **Section 7 – Diagrams and tech notes.**

3.4 UDX TEL+BT

The adapter UDX TEL+BT manages one standard phone line (POTS) and a **Bluetooth** link to pair a smartphone.



Figura 7: UDX TEL+BT

The connection and settings for the POTS lines was detailed above.

The procedure to pair a cell phone is explained in section 5.7 – TELCO.

To download the Quick Installation Guide (pdf) go to Section 7 – Diagrams and tech notes.

3.5 UDX USB

This adapter allows to connect a computer, via USB, with one AES3 input and one AES3 output.



USB TO COMPUTER

UDX-USB allows to connect a computer to UNIDEX AES3 I/O.

*When incoming streaming is enabled, AES3IN-1 is internally assigned to streaming. The external AES3 signal is disabled..

UDX-USB OUT to AES3IN*

UDX-USB IN to UX24 AES3OUT

- AES3OUT-1 = PGM (fixed)
- AES3OUT-2 = REC (fixed)
- AES3OUT-3 = Assignable
- AES3OUT-4 = Assignable

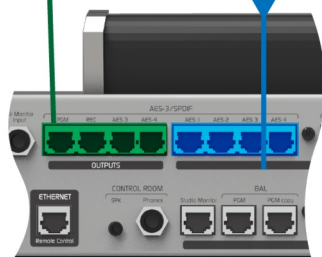

3.5.1 Input setup

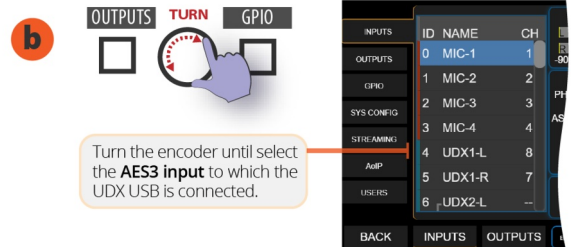
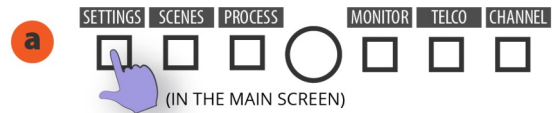



3.5.2 Output setup



3.5.3 Channel settings

a  Press **CHANNEL** on the main screen. The **CUE** buttons change to **SELECT** mode.

b  Press the button **SELECT (CUE)** on the channel that you want to edit. The console return to normal mode and shows the **CHANNEL** screen for the selected channel. To select **Virtual Channels**, turn the encoder and push it to confirm.

c  Change the **CHANNEL MODE** to **LINE**

d  To edit the **LABEL**, touch on the name. A touch keyboard will appear.

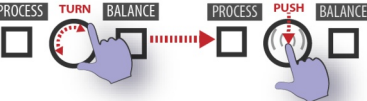
e  Turn the encoder to focus the **GAIN** or touch the control. Push and turn to change the value.

f  Set the **GAIN** so that the peaks reach **-9dBfs** on the level meter.

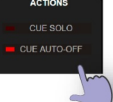
g  In the section **ACTIONS** the operator can define the behavior of **CUE** button for this channel.

WARNING

The AES3 outputs works at 48 KHz. In Windows, the recording device must be set to 48 KHz.

- In Windows10, go to System Settings and choose Sound.
- In Sound, go to Input > Device Properties.
- Open the option Additional device properties.
- Go to the tab Advanced and set the sample rate to 48.000 Hz.

3.6 StudioBox HD3 & HD5: monitoring into the Studio

The modules for monitoring **Solidyne StudioBox HD5 and HD3** resolve the sending of all monitoring signals to the studio.



Figure 8: StudioBox HD5 and HD3

3.6.1 CONNECTING

The HD3/HD5 accessories are connected to the “**Monitor Studio**” connector (UX24 rear panel), using a shielded multipair CAT-5 cable, with connection over RJ45 T568B (a 5 meter cable is included with the StudioBox). Through this cable the console sends the signals to the headphones and speakers; and receive the Talkback from Studio.

WARNING

Not connect the StudioBox output using audio RJ45 patch cords (it is not Studiohub compatible).



Figure 9: StudioBox HD5

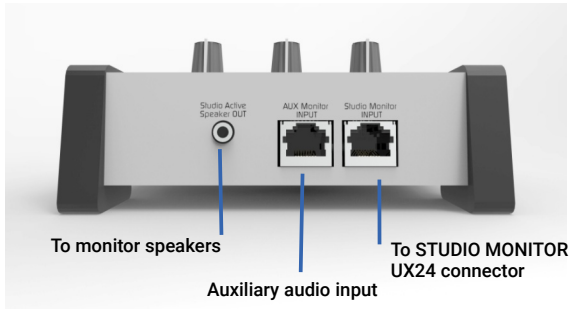

The **speaker output** uses stereo 1/8" TRS connector (mini-jack). This is a line level output, intended for use with powered speakers.

Headphone outputs use stereo 1/4" TRS connectors (jacks). Headphones with 32 or 16 Ohms of impedance can be connected (and combined).

NOTE

For HD3, the headphones outputs 2 and 3 are twin: they share the level knob and the source assignment.

The **aux input** is used to connect an alternative signal to the main assigned from the console (ON-AIR, PGM, AUD, SEND or CUE). The headphones can be switched between inputs A (console) and B (aux).

- On HD5 models, A/B switching is available independently for headphones 1, 2 and 3. Headphones 4 and 5 always receive the main "Studio Monitor" signal, assigned from the console.
- On HD3 models, headphones 2 and 3 share the assignment.

The auxiliary input is unbalanced, with RJ45 connector. The connection to any RJ45 audio output of the console, balanced or unbalanced, is made using a standard STP RJ45 cable on both ends (SOL-P25 or SOL-P50 cables).

The UX24 console supports up to three HD3 or two HD5 units, which are connected on the "Studio Monitor" output in parallel. RJ45 type "Y" ("Y" splitter) junction boxes with pin-to-pin connection are used for the connection.



3.6.2 USING THE STUDIOBOX

Using headphones into the Studio

The Solidyne HD5 accessory manages up to five headphones with independent level knobs.

HD3 allows to connect up to 3 headphones and has two level knobs. Headphones 2 and 3 are twins, sharing the level control.

The maximum volume delivered is determined by the headphone level control in the MONITOR section of the UX24. What is heard depends on the signal selection made in the console.

Use the loudspeakers into the Studio

The output for Studio speakers has a level control. StudioBox have dual A/B monitoring channel. Channel A is fed from the "Studio Monitor" connection, so the signal heard depends on the assignment on the console. Channel B receives the signal from the aux input (AUX Monitor Input).

NOTE: SPEAKER MONITORS LEVEL

Set the volume using the speakers knobs for a comfortable listening, leaving the LOUDSPEAKER LEVEL knob of the StudioBox at center position.

About the Studio Intercom

The white button have two functions:

1. When the microphones are turned off, pressing the Studiobox Intercom who is in the Studio can speak to the Control Room. Studiobox has a contact microphone for this purpose. At the Control Room, the operator will listen the signal by the console's CUE channel. The internal mic gain is adjusted with the preset "mic gain". In the console surface, the knob CUE level has no action on the HD3/HD5 mic signal, so that the Intercom will heard even if the CUE volume is zero. The operator will use the talk-back as is usual to talk with the Studio.
2. When the mics are on the air, the Intercom button only works as a tally light.

NOTE

MIC GAIN: The preset located below the mic allows to set the mic gain and therefore, the listening level for the operator at the Control Room.

About the Timer/Clock (only HD5)

Displays the current time (when the mics are off-air) or the elapsed time on-air (when the microphones are on).

The counter mode can be disabled. For this, remove the cover of the HD5 and remove an internal jumper located next to the clock. This will disable the counter feature, and the display will always shows the current time.

SECTION 4 START UP AND ROUTING

4.1 Starting up

When the console is turned on, load the operating system. When the boot sequence ends, the main screen appears and UX24 loads:

1. The user profile settled for the start up.
2. The scene used the last time, previous to turning off the unit.

The default profile is ADMIN, that has no restrictions. It can be changed from SETTIGNS screen.

On startup, UX24 do not request the user's password.

To starting up with restrict access, change the default star up user to a restricted user. If the console restarts, the operator must know the password to change to EXPERT or ADMIN profile (see below).

4.2 Inputs/outputs default routing

A scene saves the status of the inputs, outputs, routing, audio processing and channel settings. UX24 has 12 user scenes. Next tables shows the inputs and outputs configuration for the DEFAULT scene. All scenes can be reseted to this default scene.

UDX adapters requires different settings and routings. The default scene has channels settled to connect:

- One UDX-2TEL or UDX-TEL+BT
- One UDX-2MIC to add two microphones.

All channels of the default scene can be re-configured to others uses.

Go to Section 7 – Diagrams and tech notes to download a document that summarize with graphics the default settings for the factory scenes

4.2.1 Default inputs routing

The following table shows the configuration of the inputs for the default scene.

CH#	NAME	MODE	INPUT	M/ST
1	MIC-1	MIC	MIC 1	M
2	MIC-2	MIC	MIC 2	M
3	MIC-3	MIC	MIC 3	M
4	MIC-4	MIC	MIC 4	M
5*	MIC-5 UDX5	MIC	UNIDEX5-L	M
6*	MIC-6 UDX5	MIC	UNIDEX5-R	M
7**	PH-LINE1	TELCO	UNIDEX1-L	M
8**	PH-LINE2	TELCO	UNIDEX1-R	M
9	IN-ST9	LINE	STEREO BAL 9	ST
10	USB-01	LINE	USB1 L&R	ST
11	USB-02	LINE	USB2 L&R	ST
12	USB-03	LINE	USB3 L&R	ST

13	USB-04	LINE	USB4 L&R	ST
14	IN-ST10	LINE	STEREO BAL 10	ST
15	IN-ST11	LINE	STEREO BAL 11	ST
16	IN-ST12	LINE	STEREO BAL 12	ST
17	IN-AES1	LINE	AES1-L&R	ST
18	IN-AES2	LINE	AES2-L&R	ST
19	CHANNEL19	LINE	NO ASIGNADO	-
20	CHANNEL20	LINE	NO ASIGNADO	-
21	CHANNEL21	LINE	NO ASIGNADO	-
22	CHANNEL22	LINE	NO ASIGNADO	-
23	CHANNEL23	LINE	NO ASIGNADO	-
24	CHANNEL24	LINE	NO ASIGNADO	-

* Requires an external adapter UDX 2MIC.

** Requires an external adapter UDX 2TEL or 2TEL-P.

4.2.2 Default outputs routing

OUTPUT	SIGNAL	LEVEL @0 VU**
PGM & PGM COPY	PGM (fixed)	+ 4 dBu
BAL OUT 1	PGM	+ 4 dBu
BAL OUT 2	REC	+ 4 dBu
BAL OUT 3	AUX	+ 4 dBu
BAL OUT 4	VBUS	+ 4 dBu
* UNBAL OUT 5	UDX 2TEL (optional)	+ 8 dBu
UNBAL OUT 6	NOT ASSIGNED	0 dBu
UNBAL OUT 7	NOT ASSIGNED	0 dBu
UNBAL OUT 8	CUE	0 dBu
USB1	PGM	-20 dBfs
USB2	REC	-20 dBfs
USB3	AUX	-20 dBfs
USB4	VBUS	-20 dBfs
AES1 PGM	PGM	-20 dBfs
AES2 REC	REC	-20 dBfs
AES3	AUX	-20 dBfs
AES4	VBUS	-20 dBfs

* By default it's configured to connect an external adapter UNIDEX UDX 2TEL or 2TEL-P

** Output level for 1 KHz at 0VU. With PGM signal, with peaks reaching 0 VU, the output peak will be louder due to integration time of the vumeter.

4.2.3 Users and access restrictions

There are three users profiles with different restrictions:

BASIC - EXPERT - ADMIN

By default, UX24 starts using the profile ADMIN, which has full access.

The profiles EXPERT and ADMIN are password protected, but the password never will be requested at startup. To restrict the access to advanced features, the default boot profile must be changed to BASIC or EXPERT. For more details please see 4.9 SETTINGS / USERS.

4.3 SETTINGS

On this screen the user will find all the configuration options. It is accessed by pressing the **SETTINGS** button on the main screen.

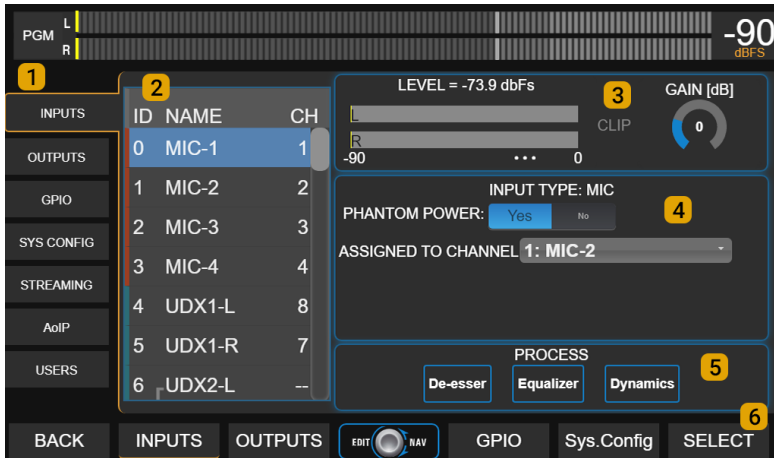

1 CATEGORIES: All routing and configuration options are classified into categories that are accessed from the menu on the left. On the right side the options of each category are shown. A category is chosen by touching the option on the screen, or by pressing the contextual button below the screen (some options are not available from the buttons).

4.4 SETTINGS: INPUTS

2 AUDIO INPUTS

List of all available audio inputs in the UNIDEX UX24. To navigate the list, turn the encoder. At the right, the options and settings of the selected input are displayed.

The list also shows the channel assigned to each input.

Stereo inputs shows as L/R pairs. For certain uses a stereo pair can be ungroup and be used as two independent MONO inputs.

- When an input is set as stereo, at the list the stereo pair appears grouped.
- When an input is set as mono, L/R ungroups and can be selected as independent channels.

3 GAIN

Changes the input gain. When an input is selected on the list, the focus is on the GAIN control. Turning the encoder changes the GAIN value. Push the encoder to switch between the list-navigation or gain value editing.

The level indicator shows the peak value in dBfs.

The gain control is also available on CHANNEL screen.

Quick gain set:

1. On the channel that want to adjust, play high loudness music (i.e. mainstream

pop); or speak to the mic with realistic "on-air" voice level.

2. Raise the fader to the nominal work zone (the zone marked between -10 y -20 dB).

3. Adjust the input GAIN until see that main VU Meters reaches 0 VU.

4 INPUT FEATURES

The features that appears in this zone depends on the input that is currently selected.

INPUT TYPE: This information is present for all cases. Shows the input type: MIC, LINE, UDX, USB, AES.

MODE: Sets the input mode as stereo or mono. When an input is used as mono, left and right channels works as independent channels.

ASSIGNED TO CHANNEL: Define the channel, from 1 to 24, to which the signal of that input is sent. The channel is chosen from the touch screen, from a drop-down list. This option is also available on the CHANNEL screen, from where it can also be edited.

PHANTOM: This option is shown only for MIC inputs. Turn on or off 48V phantom power for that input.

UDX TYPE: This option is shown only for UNIDEX entries. Define the type of external adapter connected to the input. The model is chosen using the touch screen, from a drop-down list.

When a UNIDEX input is used as a balanced line input, UDX TYPE must be LINE (default).

5 PROCESS: Shortcuts to the audio processes available in each input. In the usual operation, the processes are usually accessed directly from a channel.

6 SELECT: In the screen INPUTS, the function SELECT toggle the buttons CUE/SELECT to the mode SELECT, to quick access to the input assigned to a fader.

4.5 SETTINGS: OUTPUTS



Output settings

1 – OUTPUT LIST

List of all available outputs. To select an output, turn the encoder. Options and settings of the selected output are displayed at right.

2 – OUTPUT GAIN

Adjusts the output level. To change the value, turn the encoder. Pressing the encoder switches between the navigation of the list and edition of gain value.

For **analog outputs**, the level is expressed in dBu referred to 0VU peak (default level + 4dBu).

For **digital outputs**, the gain is expressed in dB. The nominal output level (gain 0) is -20 dBfs referred to 0VU (1KHz @ 0VU = -20 dBfs).

3 AUDIO MODE

Switch the output mode between mono or stereo. As with the inputs, a stereo output can be used as two independent mono outputs (for example, external UDX 2TEL adapters use mono outputs for sends).

4 INTERCOM

Assign an Intercom button to this output. When the operator press this Intercom button, the talk-back microphone is send to this output replacing the current signal.

5 STUDIO B SPEAKERS

This option enables the output for connection of monitor speakers in Studio B. When the microphones assigned to Studio B are activated, this output will be muted.

6 SOURCE

Sets the signal source for the output. Sources can be: PGM, REC, AUX, VBUS; CUE; STUDIO HEADPHONES; TALKBACK; MIC-1; MIC-2; MIC-3; MIC-4 and UDX IN 1 to 8.

4.5.1 MIX MINUS

A MIX-MINUS output is a special mix in which the signal of a given input is SUBJECTED from the mix. An application case is the return to the telephone line. If the return contains, for example, the PGM signal, this PGM mix should not contain the audio from the phone line, because it would generate a feedback loop (the audio from the phone line would be re-injected into the line). A MIX-MINUS of PGM is sent to the line; that is, the PGM signal MINUS the telephone line audio.

Outputs 5 to 8 and USB outputs can work as MIX-MINUS or normal (DIRECT) mode. This outputs shows the following settings options:

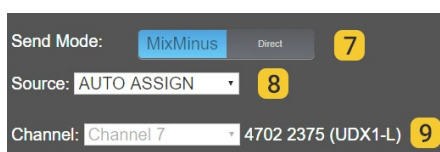

7 SEND MODE

Set the output mode as DIRECT or MIX-MINUS.

DIRECT is normal mode for the outputs. The MIX-MINUS is disabled. The signal assigned at field SOURCE, sends directly to the output.

MIX-MINUS: When an output works in MIX-MINUS, certain input signal are not mixed to this output.

8 MIX-MINUS SOURCE: BUS for the MIX-MINUS: PGM, REC, AUX; VBUS or AUTO ASSIGN.

The option AUTO ASSIGN dynamically changes the BUS, according to the assignment made on the channel. In this mode, a priority order is set depending on the channel assignment (when the channel is send to two or more buses). The priority is: PGM - REC - AUX - VBUS. If the channel is assigned to all buses, the mix-minus is done against PGM. But if the channel is assigned, for example, to REC and AUX, the mix-minus is done against REC.

9 CHANNEL (mix minus mode): Shows the input associated with the selected output, and the channel assigned to that input. This field is read-only. The input associated for mix-minus is prefixed and cannot be modified.

In order for an output to be used in MIX-MINUS mode, the associated input must be assigned to a channel. If the input is not routed, the MIX-MINUS mode remains disabled.

OUTPUT	LINKED INPUT
OUT5-L	UDX1-L
OUT5-R	UDX1-R
OUT6-L	UDX2-L
OUT6-R	UDX2-R
OUT7-L	UDX3-L
OUT7-R	UDX3-R
OUT8-L	UDX4-L
OUT8-R	UDX4-R
USB OUT1-L	USB IN1-L
USB OUT1-R	USB IN1-R
USB OUT2-L	USB IN2-L
USB OUT2-R	USB IN2-R
USB OUT3-L	USB IN3-L
USB OUT3-R	USB IN3-R
USB OUT4-L	USB IN4-L
USB OUT4-R	USB IN4-R

4.6 SYS CONFIG

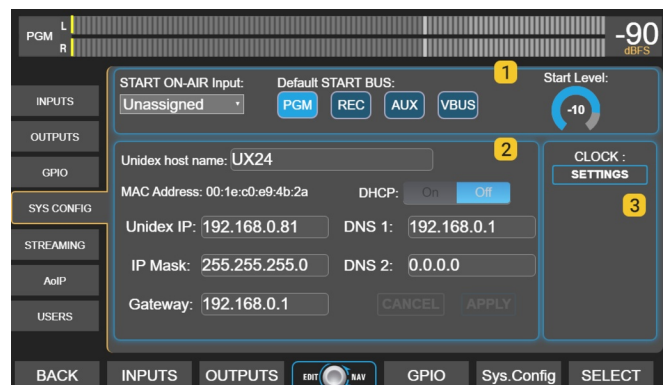

1 CHANNEL ON-AIR ON STARTING

Set one input that will be aired in case the console restarts due to AC power failure.

Start on-air input: Select an input. For stereo sources, select any input of the stereo pair. The input must be assigned to a channel (hardware or virtual). The console always starts with the last scene used. If the station is in automated transmission, make sure that in the scene, the input set for "start on/air" be assigned to a channel. The audio source connected to that input must also be re-established by itself.

Default BUS: Buses that will be turned on at the channel associated with the "default" input.

Start Level: Channel's fader level. In physical channels, this level is independent of the position of the mechanical fader, but if the fader is moved, the level will change to the current position of the fader.

2 NETWORK SETTINGS (Ethernet control)

LAN settings for remote control. By default the device works with DHCP enabled. The IP assigned by the router is shown on the main screen (UNIDEX IP).

The IP address allows the user access to the console using a web browser. UX24 has an internal HTML5 server, which allows remote control over all the operation features and settings.

3 CLOCK SETTINGS

Shows a pop-up box to set the time. The clock can be settled in three ways:

1. Connecting the UX24 to a LAN with Internet using **Ethernet STREAMING** port. In this case the sync is full automatic. No other action is required.
2. Connecting the UX24 to a LAN with Internet using **Ethernet CONTROL** port. In this case an internal clock UX-Core is synchronized. **The user must sync manually the internal computer** (which controls the touch screen interface) by touching the option **SYNC FROM UX-CORE** showed on screen.
3. Manually from the screen. Used when the LAN do not have Internet access.

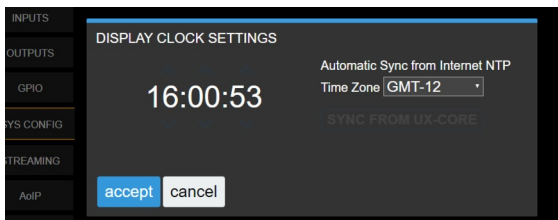

NOTE

When UX24 access to Internet, it synchronizes with a World Clock (UTC). The user must define the *Time Zone*.

4.7 Streaming

UX24 gives two independent *audio streams*, and can receive one incoming streaming. The options for outgoing streaming are:

1. **RTP stream** for point to point link.
2. **Streaming** for upload to *icecast/shoutcast servers*

4.7.1 Streaming signal and send level

Streaming takes the program signal from the AES-1 PGM output, both for uploading to Icecast / Shoutcast servers and for RTP.

If the gain of the AES-1 PGM output is changed, the send level for streaming is changed.

4.7.2 UP-STREAM (TX)

This option is accessed from the console by pressing SETTINGS on the main screen. SETTINGS -> STREAMING has four tabs to configure the different features. The UP-STREAM tab presents configuration options for uploading to Icecast or Showtcast broadcast servers.

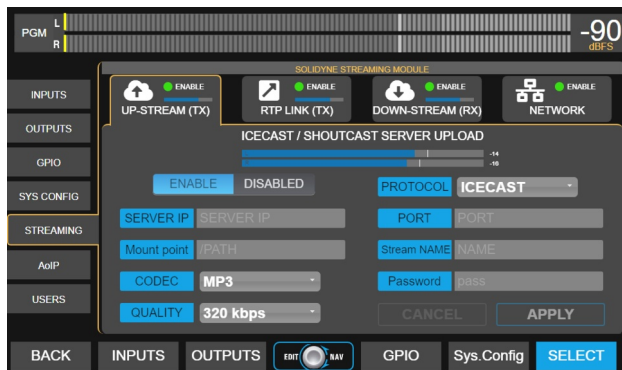

4.7.2.1 ICECAST/SHOUTCAST STREAM

ENABLE/DISABLED: Enables the streaming send for *Icecast/Shoutcast*.

PROTOCOL: Define if the server is Icecast or Shoutcast.

SERVER IP: IP address to which the streaming is sent. Is the address of *Icecast/Shoutcast server*.

PORT: TCP listening port for the server.

MOUNTPOINT: A unique name that identify the *stream* at the *Icecast/Shoutcast server*.

CODEC: Audio format for the transmission. The current version of firmware only supports MP3 coding.

PASSWORD: Password to access the server (if needed)

QUALITY: Audio bitrate.

APPLY: Name that identify the stream.

NOTE

Settings for *Icecast/shoutcast* usually are given by the *streaming provider*.

4.7.3 RTP STREAM

The RTP LINK tab presents configuration options to send streaming to a specific IP address. It is used to create point-to-point links, for example, to send the program signal to the transmission plant (STL).

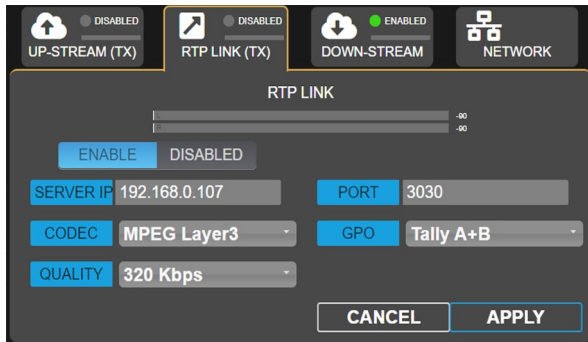

ENABLE: Enables the streaming send for *Icecast/shoutcast*.

DESTINATION ADDRESS: Target IP address for the outgoing stream.

PORT: Transmission TCP port.

CODEC: Audio format for the RPT stream (PCM or MP3).

QUALITY: MP3 for MP3 or sample rate for PCM.

GPO: Sends the tally light signaling via TCP/IP to compatible Solidyne devices. There is two data lines that sends the following signals:

Studio A & B (lines 1 and 2 respectively)

Studio B & A (inverted)

A+B (the signal is send in both lines when any of both studios are on air).

4.7.4 DOWN-STREAM (RX)

Settings for the incoming streaming. Supports the following formats:

- **RTP audio streams** in PCM 16 44.1KHz or MP3.
- Public **http or mms audio streams** coded in PCM 16 44.1/48 KHz, MP3 or Opus.

AUDIO SIGNAL

When the module DOWN-STREAM is ENABLED the decoded audio signal is sent to the input AES-1, that changes its name to STREAM-1. The connector AES-1 on rear panel is disabled.

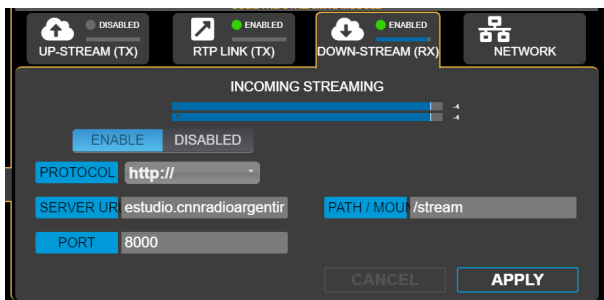

4.7.5 STREAMING NETWORK

Network settings for the UX24 streaming module. At the present version this settings are fixed and depends on the settings of the LAN (DHCP).

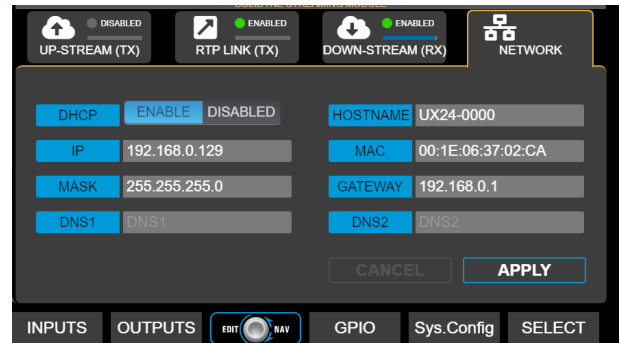

4.8 GPIO

UX24 have 4 GPI (*general purpose inputs*) and 8 GPO (*general purpose outputs*). The actions for each GPIO sets in the following screen:

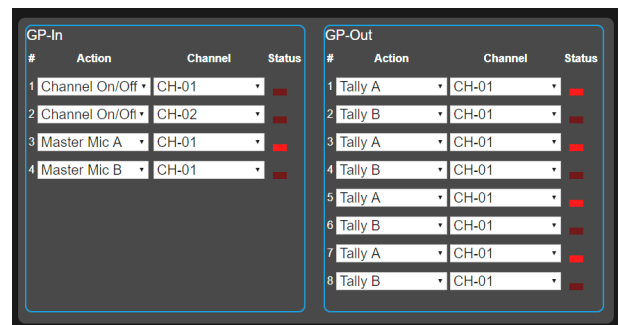

Each GPI/O can be associated to any channel and to carry out certain actions.

The actions available for the GPI are:

- UNASSIGNED
- CHANNEL ON/OFF
- CHANNEL MUTE
- MASTER MIC A
- MASTER MIC B

The actions available for the GPO are:

- UNASSIGNED
- CHANNEL ON/OFF
- TALLY A
- TALLY B
- TELCO RING
- OUTPUT +12V (solo en GP08)

Examples:

The following: **GPI 1 | CHANNEL ON/OFF | CHANNEL 1**

...will cause that **Channel 1** turn on/off according to the signal present at the input GPI 1.

The following: **GPO 1 | CHANNEL ON/OFF | CHANNEL 6**

...will cause that output GPO 1 changes its status when the Channel 6 is turned on or off.

To know more about GPIO please see the section 2.4 – GPIO.

4.9 SETTINGS: USERS

UX24 has three user levels: ADMIN, EXPERT, BASIC. The ADMIN and EXPERT users are password protected, which are defined on this screen. Only the ADMIN user can change passwords.

Default passwords are user names, in lower case (admin and expert).

DEFAULT USER

Defines the user that loads when the console starts. By default ADMIN.

When start up, the system never will ask by password, no matter which is the default starting user.

To restrict access to advanced features, change the default boot user (ADMIN) to BASIC or EXPERT, depending on the level of restriction needed. If the console starts with a BASIC profile, passwords for EXPERT or ADMIN must be known in order to access restricted features.

4.10 AoIP

UNIDEX UX24/A67 has the module DANTE for 16x16 networked audio. This screen shows the settings and status of DANTE network. The DANTE network and devices configures from DANTE Controller software.

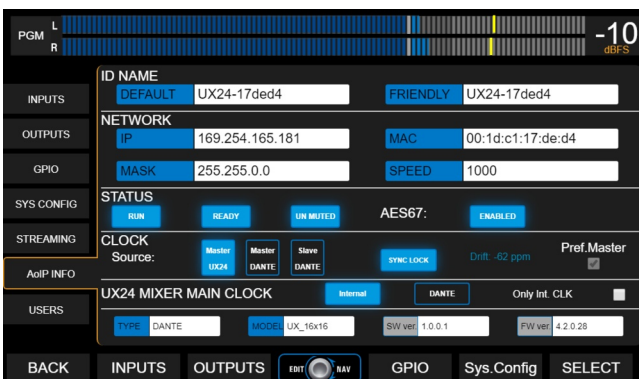

Download from the web site (<http://www.solidynepro.com/unidex-V/>) an example diagram that shows a full implementation of UX24 with DANTE. This document includes all Audinate's Dante links needed.

Direct link:

[Example diagram with DANTE – information and links](#)

SECTION 5 OPERATION

5.1 Overview

The mixer console presents to the operator different area with controls:

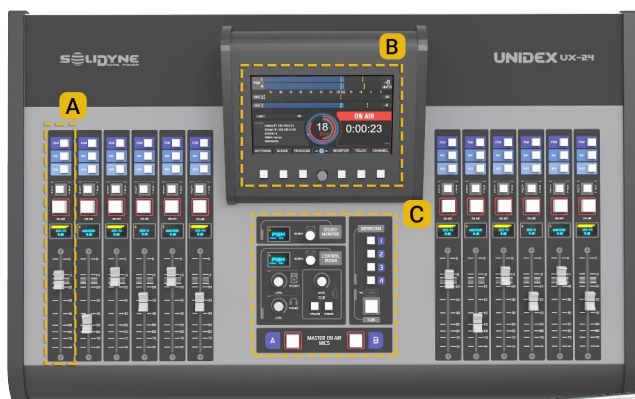

A Traditional controls on each channel, with faders, assignment buttons, ON/OFF and previous listening or CUE. They operate in a traditional way and allow direct command of POTS, VoIP and cell phones via Bluetooth (using external adapters UNIDEX TELCO).

B A main touch screen, from where certain functions are controlled: audio processors, “virtual” channels (channels not assigned to real faders), simplified functions for telecommunications, scenes. This screen also contains the level meters, clock and counter.

C Monitoring and talkback.

D Remote control using an external computer. Using a web browser for remote access via HTML5 graphical interface, all features of UX24 can be operated. The WEB interface is a great tool for operate the virtual channels. A tablet can be used as an extension of faders; or a large touch screen monitor can set up a remote studio.

5.2 Main screen

1 LEVEL METERS: The main screen contains the level meters for: PROGRAM (PGM), REC, AUX and VBUS. The indicators show average level in VU (slow moving blue bar), and peak level (floating yellow segment).

The scale is in dBfs. -20 dBfs corresponds to 0VU. The level scale is valid for all meters. The numbers shown on the right indicates the current maximum level, which can be expressed in VU or dBfs. To switch it, tap on the number on the screen.

Main meter remains visible on all screens and can be switched to other buses by tapping on the text “PGM”.

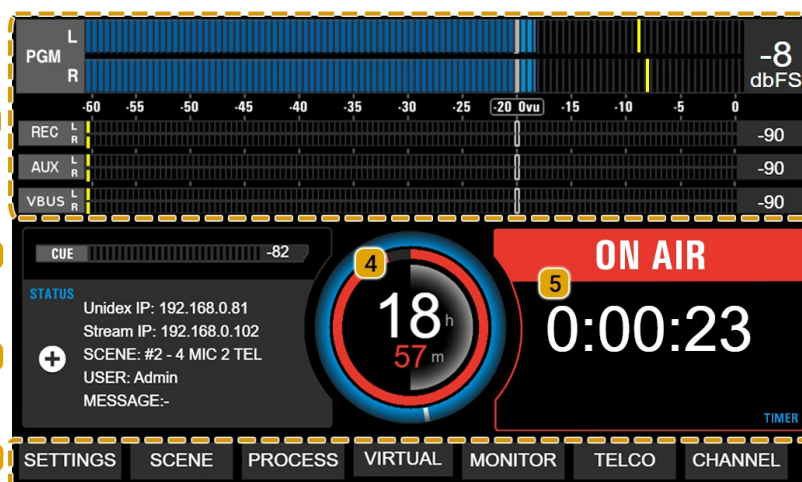

LEVEL ON THE OUTPUTS AND METERS

The level meters show the signal level on the BUSES.

For digital outputs, the level indicator matches the level of the output if the output gain is zero. If the gain of an output is changed, the level at that output will not match that indicated on the meter.

Analog outputs are referred to 0VU = -20 dBFS with nominal level + 4dBu for balanced and 0dBu for unbalanced. Setting an output level above the nominal level reduces headroom, and the output may hit clipping before the level meter shows it.

2 CUE LEVEL: Shows the level of the CUE signal. This level is posterior to the knob CUE Level.

3 STATUS:

Unidex IP: IP address to access to the UX24. Entering this IP into a web browser (Chrome recommended) the users access to the remote control interface.

Stream IP: Destination IP address for streaming.

SCENE: Indicates the current scene.

USER: Name of the current user profile. There are three users profiles: ADMIN, EXPERT and BASIC.

MSG: Shows system messages.

“+” ADVANCED STATUS: It presents advanced options for system maintenance (see 2.1 – Power on/off and resets). The most important item is the safety shutdown for the internal CPU, which must be done before a hardware power down.

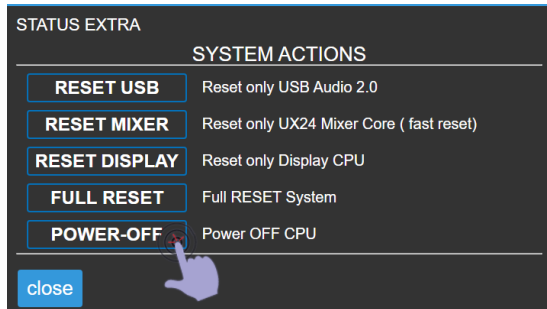

4 MAIN CLOCK: Shows the current time. The time synchronizes with the LAN with Internet access, or can be settled manually. Please refer to 4.6 - SYS CONFIG.

5 ON-THE-AIR COUNTER: Indicates when the microphones are ON; showing an ascendant count in hours:minutes:seconds.

6 MAIN OPTIONS: The different screens are accessed by pressing the contextual buttons located below each menu item. The action of this buttons changes according to the context on each screen. Into the screen, the options are navigated and edited using the touch screen and the encoder, as explained next.

All screens keep visible the PGM level meter. The operator always sees the level of the air signal. Next, an overall description of each screen.

SETTINGS Only the ADMIN user profile has access. This menu option is not enabled when working at the BASIC or EXPERT level. It contains all the advanced and system configuration options, including the assignment of inputs and outputs.

SCENE Access the editing and creation of scenes. Allows changing the user profile, each with different access permissions.

PROCESS Access the audio processors: parametric equalization, dynamic compression, de-esser and noise gate. The available processes change for each type of input.

VIRTUAL Pushing the encoder at main screen, the user access to on-screen mixer for virtual channels.

MONITOR It shows the assignment of monitoring sources for the Studio and the Control Room. It contains advanced functions related to monitoring in speakers and headphones.

TELCO It has a management interface for channels connected to telephone lines, Bluetooth phones or IP voice software. It has all the necessary functions, including a keyboard to dial from the console.

CHANNEL This option shows the screen that summarizes the status of the selected channel. The CHANNEL screen shows information and gives access to basic features such as gain control and panning; and to some advanced options such as audio processes and inputs routing.

SCREEN SAVER
All displays automatically turn off after 15 minutes of in-activity. Slightly moving a fader or pressing an Intercom button activates the displays.

5.3 Channels

UNIDEX UX24 is a 24-channel mixing console. In the basic configuration, it has 12 channels with 100mm "real" faders; and 12 channels with "virtual" faders that can be operated from the on-board display, or from an external computer or a tablet.

Optionally, up to two UX6 expansion modules can be added, to obtain a surface with 18 or 24 physical faders.

All channels have 4 mix buses. The channels in the hardware have three buttons for quick assignment to the PGM, REC and AUX buses; plus a fourth bus is assignable from the screen (VBUS).



Each channel presents the following areas:

1 BUSES: Each of the 24 channels can be assigned to 4 mix buses: PGM; REC; AUX; VBUS

On the UX24 surface physical channels 1 to 12 are assigned to PGM, REC and AUX directly from three assignment buttons present on each channel. When is assigned, the button lights orange.

The assignment to the VBUS is made from the touch screen, from CHANNEL screen or from the WEB interface.

2 CUE/SELECT: This button have 3 functions:

- CUE, pre-fader listening (PFL)
- SELECT, channel selection
- TALKBACK in channels with mode=TELCO

In normal use works as CUE, to listen to the signal present on that channel, previous to the fader and the ON-AIR button.

The **SELECT** function is used to select a channel and perform some action, for example, set the gain, edit the label, etc. When the mode is **SELECT** the CUE buttons change to blue and **SELECT** is indicated on the OLED. The use of this mode is explained later.

TALK-BACK mode is exclusive to TELCO channels, which handle telephone lines. By holding down CUE, the talk-back microphone is enabled to talk to the phone line.

3 ON-AIR button: It's the ON/OFF button. When is ON, the signal sends on-air (to the mix buses). The level is set with the main fader.

4 DISPLAY: OLED screen that shows:

- The input level previous to fader. If the input signal is reaching 0 dBfs at the A/D converter, a **CLIP indication** appears. To solve this condition, turn down the input gain.
- Name or label that identify the channel.
- States or special modes like **SELECT** or channel functions like **TELCO**.

OLED ENERGY SAVER

The brightness of OLED displays is reduced after 5 minutes of inactivity. After 15 minutes, OLEDs are turned off. Any action on the channel controls or Intercom buttons restores the displays.

5 MAIN FADER: 100mm soft touch faders. Sets the level for the signal on mix buses.

The level adjusted by the fader on the surface can be changed from the touch screen (**CHANNEL**) or externally from the control web interface. When this happens, the current attenuation value will not match the fader position, because the faders are not motorized. This condition will be indicated on the OLED screen, which will flash showing the current level value.

When the fader on surface moves, the value is progressively updated to the current fader position.

5.4 Monitoring section

In this section the operator assigns the signals that will be heard on the monitor speakers and the headphones of the Studio and Control Room.

Also locates the Master buttons A and B for microphones activation, the CUE level knob, the talk-back and the Intercom buttons.

The knobs 1 and 2 (see next image) are selection encoders that allows to navigate the options on the screen by turn it. They have push function to confirm an option.



To choose a signal source proceed:



Turn the encoder. The options will be displayed on the screen, and the text will remain flashing until the operation is confirmed.



To confirm the selection, push the encoder. The audio is switched when confirming the operation. If the knob is turned but not pressed to confirm, after 10 seconds the action is canceled and the screen returns to the current source.

By pushing the encoder (without turn it) returns to the previous source, which is indicated below in small letters. This feature allows to switch the listening between two sources with a simple touch.

1 STUDIO MONITOR: Allows to select a signal source for the Studio monitoring. The options are:

AIR-IN PGM REC AUX VBUS CUE

The send level for studio speakers and headphones can be adjusted from the touch screen in the **MONITOR** section (see below). Usually this level is fixed and each user within the studio adjusts their level from a headphone distributor.

On radios operating in a single room, the monitor speakers can be connected to the Control Room output which has a physical volume knob (**3**).

2 CONTROL ROOM: Allows to select a signal source for the Studio monitoring. The options are:

AIR-IN PGM REC AUX VBUS

MUTING THE CONTROL ROOM SPEAKERS

When a microphone is used into the Control Room, it can be configured to mute the CR speaker output when that microphone is turned on (see 5.6 The screen 'Channel' - Item 8).

The above is also used in radios that works in a single room, with no separation between the Studio and the Control Room. In this case, the monitor speakers can be connected to the CR speaker output, in order to use the volume knob on the console panel (note that there is not volume physical knob for Studio Speakers). In this case, all the microphones are configured as located into the Control Room, to enable the muting for the Control Room speakers.

3 CONTROL ROOM MONITORING LEVEL: It is a rotary attenuator that handles the level of the control speakers. The output is line level, to connect active or powered speakers. Note that the maximum level reached will be affected by the speaker's own level adjustment.

4 CONTROL ROOM HEADPHONES LEVEL: A rotary knob that manages the level of the operator's headphones.

5 CUE LEVEL: It is a rotary knob that controls the level of the CUE bus. The main screen shows a CUE level meter, in dBfs. This indicator shows the level after the CUE level control; therefore, there is no indication if the knob is zero.

The **SPEAKER** and **PHONES** buttons inject the CUE signal into the speakers and/or headphones of Control Room.

When these buttons are activated, the CUE signal mixes with the currently monitored signal (shown on the SOURCE screen). The monitored signal reduces its level automatically when a CUE signal is present. The degree of attenuation can be defined in the MONITOR section.

The CUE bus can be assigned to any output, for connection of **auxiliary CUE loudspeakers**. By default, CUE is on UNBAL 8.

5.4.1 Screen MONITOR

By pressing the button **MONITOR** or this option the user access to the MONITOR screen.

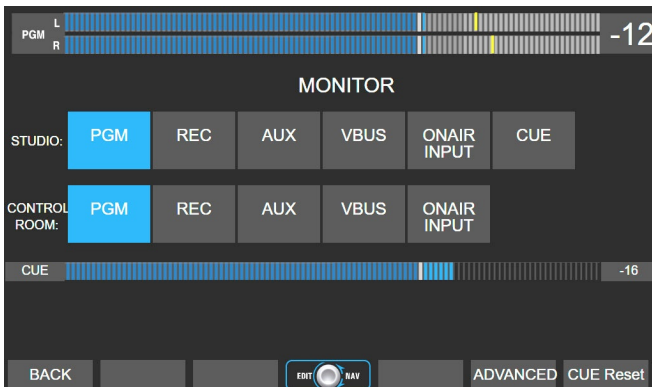

This screen replicates the **signal assignment** for the Studio and Control Room, but showing the options in the **traditional way with a selector keypad** (now they are touch buttons!). To change an assignment, press the option on the screen.

There is a **CUE level meter**, in dBfs. The level shown is after the CUE level control (post-fader). There will be no level indication if the CUE knob is zero.

The **CUE Reset** option turns off all active CUE buttons, both physical buttons and virtual channel CUE buttons.

ADVANCED opens a new screen, with the advanced monitoring options:

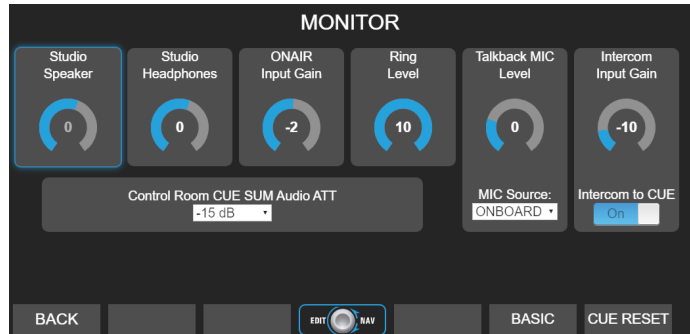

Navigation

TURN
Turn the encoder to navigate the controls.

PUSH
Push the encoder to select a control.

TURN
Turn the encoder to change the value of the selected control.

PUSH
Push the encoder to confirm the new value. When do it, the encoder returns to the navigation mode.

TOUCH
Functions **Intercom to CUE** and **CUE to speaker** are toggled by touch screen.

STUDIO SPEAKER

Audio level for the studio loudspeakers at the output "Studio Monitor" (rear panel).

STUDIO HEADPHONES

Change the audio level for the headphones at the output "Studio Monitor" (rear panel).

NOTE: MONITORING OUTPUT LEVEL

To change the level for studio loudspeakers and studio headphones, take in mind that a very low level at the console's outputs will need too much gain in the loudspeaker and headphones amplifiers, causing SNR loss.

RING LEVEL

Set the volume on CUE for the calling "ring". A ring sound is played when incomes a call (for POTS and bluetooth).

TALCKBACK MIC LEVEL

Set the level for the talk-back mic signal, which is send to the Studio monitoring, Intercom and TELCO.

TALK-BACK MIC SOURCE

Set the microphone used for talck-back (Studio monitoring, TELCO and Intercom).

Available options are: The built-in mic, or the inputs **MIC-1 to MIC-4**; **UNIDEX-4 L** and **UNIDEX-4 R**.

The input that is assigned to talk-back can be assigned to any channel at the same time. This way, these mic can be used to talk privately with the to talents, or to talk with the audience on-air.

INTERCOM INPUT GAIN

Is the level at which signals coming from Solidyne Studio Box (*reverse talkback*) and UDX INTERCOM (coming soon) mixes to the bus CUE.

Intercom to CUE: Enables or disables the return of Intercom signals to the CUE bus.

CONTROL ROOM CUE SUM AUDIO ATTENUATION

Set the dimm value applied to the monitored signal at the Control Room when a CUE signal is mixed (on speakers or headphones).

5.5 THE FUNCTION SELECT

UX24 has a 7" touch screen, which is used to operate many operating functions. The screen has 6 quick access buttons and a rotary encoder. The controls are contextual, that is, the actions they perform change according to which section or screen is active.

The SELECT mode temporarily changes the function of the CUE buttons to *channel selection buttons* (SELECT). It is used to choose a channel and operate on it. The touch screen shows the information of one channel at a time. For example, to adjust the EQ of a channel, the channel must be chosen to view the corresponding EQ controls.

Three actions can activates the mode SELECT:

1. Pressing the option CHANNEL at the main screen.
2. Pressing the option PROCESS at the main screen.
3. Pressing the option SELECT on the CHANNEL screen or a PROCESS screen (EQ, compressor, etc.).

When the SELECT mode is active, the CUE buttons light blue, and the channel OLED displays indicate SELECT.

It is possible to choose a channel in two ways:



MODE A

Pressing the button CUE/SELECT. The channel is selected and CUE buttons returns to its normal function.



MODE B

Turning the encoder to navigate the channels. The encoder explore the 24 channels, whether physical or virtual.



To confirm the selection press the SELECT button. When confirming, the SELECT mode is disabled.

5.6 THE SCREEN "CHANNEL"

All values and configurations of a channel appears summarized on the channel screen. The operator always has access to basic functions (eg, input gain). Advanced settings requires access to the ADMIN profile.

NOTE

There are 3 users profiles. The access to advanced configuration options is only allowed for the ADMIN.

To access to the CHANNEL SCREEN proceed:

1. Press the button CHANNEL at the main screen. This shows on display the CHANNEL screen of last selected, and enables the mode SELECT. Notice that the menu option CHANNEL changed to SELECT
2. Choose a channel. The hardware buttons CUE/SELECT allows the direct selection of a channel. While the function SELECT remains active, different channels can be successively selected to compare their values.

VIRTUAL CHANNELS are selected turning the encoder, which navigates the 24 channels. The channel's name zone appears in light blue for hardware channels, and in purple for virtual channels.

3. To confirm the channel and leave SELECT mode, on the screen press the SELECT button or push the encoder. The selec mode is also canceled when a parameter is modified for the selected channel.

CHANNEL'S SCREEN. Shows features, settings and basic controls for the selected channels.

Allows to access to the input/output routing and the audio processing screens.



1 PGM VUMETER: Shows the program output level in VU, with peak retained. This meter remains visible on all screens.

The number showed on the right is the peak value, which can be expressed in VU or dBfs. To toggle it, tap on the value. The VU/dBfs unit change takes effect on all meters.

By touching on text "PGM", the level indicator changes successively to show the AUX, REC, or VBUS buses.

2 BALANCE: Left / right balance adjustment. In mono inputs is the PAN-POT control. To change the value:

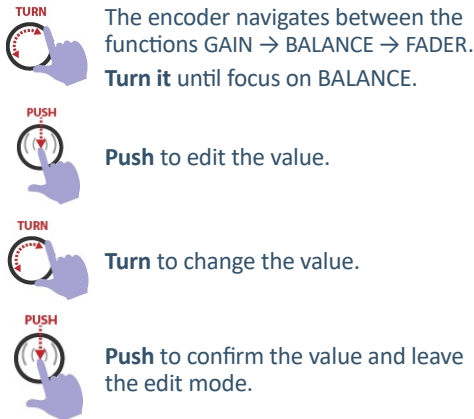

3 MAIN FADER: Set the level of the signal for all buses. This level is shown at the vu-meters.

On channels with hardware faders, the faders on the screen reflects the position of the hardware faders. If the fader is changed on the screen the level changes, but the mechanical fader remains in the same place, since they are not motorized.

When the level of a hardware fader is changed by software, the OLED screen shows the current level flashing, to indicate that it does not match the position of the hardware fader. The fader level on the screen shows always the current level of the channel.

NOTES

Although virtual channels are 100% operational from the touch screen, for convenient operation it is recommended to use the remote web interface, which can run on a larger screen or tablet.

The level at the outputs and vu-meters indication can differ since outputs have gain offset. Level meters and outputs matches when output gain control is set at the nominal level for this output.

4 BUSES: For hardware channels, reflect the assignments to the mix buses according to the PGM, REC and AUX buttons. For virtual channels, they allows to assign the channel to the output buses. In both cases, the user can assign the channel to the VBUS bus (which does not have a physical button on the console's surface).

The assignment to any of the buses can be turned on/off by pressing the corresponding button on the touch screen. In the hardware channels, the status will be reflected in the button light. The same is for the CUE bus.

5 NAME: Allows to enter a name for the channel. Maximum extension is 10 characters. This name is shown on the OLED display.

6 INPUT CONFIG: It contains the input gain control; shows the input assigned to the channel and other information associated with the input.

Only the user **ADMIN** can access the input settings by touching SETTINGS, or assign the input from the drop-down menu.

GAIN Set the input gain, in dB. To change it:

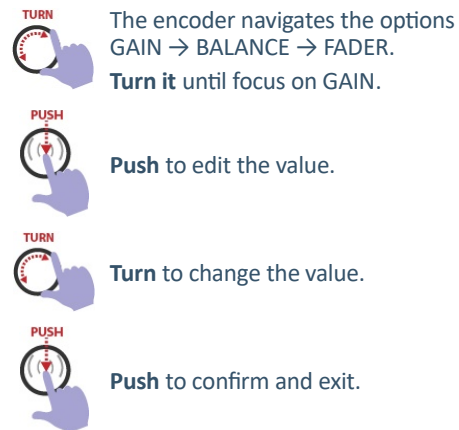

7 MODE: The mode changes the behavior and configuration options available on the channel. The mode is set according to the type of signal that the channel will manage. To change it, touch the option on the touch screen and select a mode from the drop-down menu.

There are three channel modes:

LINE For channels that manages any type of source that not be microphones or communications.

MIC It is the mode used for channels that operate microphone signals. The microphones can be connected to the on-board mic inputs; they can be connected to external UDX 2MIC or DMIC adapters; or they can be wireless microphone receivers or third-party preamps connected through line inputs.

TELCO It is the mode used for channels that manage communications (land lines, Vo-IP, Bluetooth cell phones). Channels defined as TELCO can remotely control external adapters UDX 2TEL, UDX 2TEL-P and UDX TEL+BT.

8 ACTIONS: This options defines the behavior of the channel and some special features. The options here availables will change according the channel's type (MODE).

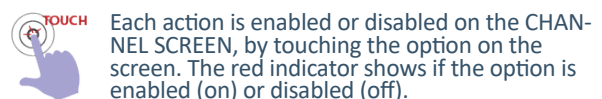

CUE SOLO and CUE AUTO OFF

This actions are available for all channels.

CUE SOLO

If enabled, when a CUE is turned on all CUEs of other channels settled as CUE SOLO turn off. Only the channels working as "CUE SOLO" are affected. For others channels, one or more CUE buttons can stay on.

If all channels work in CUE SOLO mode, there will always be only one CUE turned on. A usual configuration is to work the lines as "CUE SOLO" mode (computers and audio players) and the microphones and TELCO channels as "CUE NORMAL" mode.

CUE AUTO OFF

If enabled, CUE is turned off when the channel is on-air (ON-AIR button on and fader raised).

ACTIONS FOR "MIC" CHANNELS

Following actions are available only when MODE=MIC.

MASTER MIC A & MASTER MIC B

Allow you to assign the channel to master buttons A or B. All channels assigned to a master button are turned on simultaneously when the button is pressed.

A channel assigned to a master button can always be activated independently by pressing the ON-AIR button of the channel.

STUDIO A & STUDIO B

Are used when working with two studios. Allows you to associate a microphone channel with signaling outputs A or B; so that depending on the location of the microphone, its activation turns the light "On Air" in the corresponding studio.

CTRL ROOM MIC

Are used when a microphone is located at the Control Room. It causes that when turning on that microphone, the Control speakers are muted, not the Studio speakers.

9 PROCESS: It shows the audio processes available for that channel, and if they are activated. They can be turned on / off by touching the process name. To change the settings, touch the EDIT option (see PROCESS screen)

The available processes are not in the channel, but depend on the input that the channel has assigned.

10 OUTPUT ROUTING: Shows if the channel is associated with a direct output. An example of this is the external adapters UNIDEX UDX 2TEL, which have an associated output for sending signals to telephone lines.

The ADMININ user can access the configuration by touching SETTINGS.

5.7 TELCO - COMMUNICATIONS

TELCO contains all the controls for handling telephone calls, including a DTMF dialer. The essential actions can also be done from the console's surface using the CUE and ON-AIR buttons (see next).

This screen only shows channels defined as TELCO (see CHANNEL screen). They are those associated with telephone lines and Bluetooth cell phones that are connected by the external adapters "UDX TEL".

TELCO screen layout looks like the following:

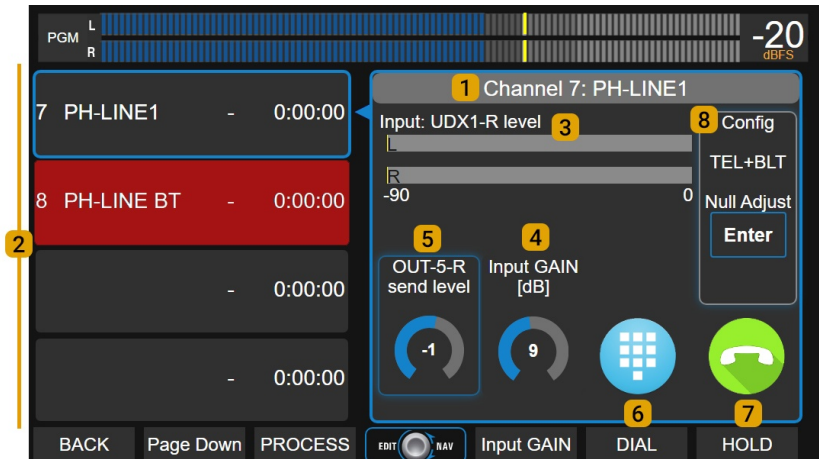

1 SELECTED LINE: Name and channel number of selected line. To select a line, touch on the list. The current selected appears with a blue frame and an arrow.

2 AVAILABLE LINES: Shows of up to 4 TELCO channels. When there are more than 4 channels, the "Page Down" button allows to scroll the channel list.

Each row corresponds to a channel and shows the label; a counter for the elapsed time on-air/on-hold and the status of the line signaled by colors: YELLOW for incoming calls; GREEN when a line is hold and RED when it is on-air.

3 LEVEL: Level for the incoming signal. It also shows the name of the input assigned to the UDX adapter.

4 INPUT GAIN: Display the gain control that correspond to the input assigned to the UDX adapter. To change the value use the encoder.

5 SEND LEVEL: Displays the gain control that correspond to the output assigned to the UDX adapter for sending audio to the line. To change the value use the encoder.

6 DIAL: DTMF dialer to make callings from the console.

7 HOLD/HANG UP: For incoming calls, it allows to take the line and leave it on hold. When a call is on-air, it allows to end the communication.

8 CONFIG: Reports the type of adapter associated with the channel, and its settings options. The options on this area changes according the UNIDEX adapter.

5.7.1 NULL ADJUST

This option is shown only for POTS lines (UDX 2TEL; 2TEL-P and TEL+BL). Adjusts the rejection factor (see 2.11.3 - UDX 2TEL and 2TEL-P).

5.7.2 BLUETOOTH PAIR

This option is shown for TELCO Bluetooth channels. It turn on Bluetooth discovery mode to pair a phone.

By linking the cell phone to the console a wireless link is created between both devices. The phone registers the unique identification code (ID) of the console (the UDX adapter). Pairing is done only once. Multiple phones can be paired, but only one can be linked to UNIDEX at the same time.

ABOUT THE CELL PHONE DISTANCE

Although the cell phone can be up to 5 meters away from the UDX Bluetooth adapter, IT IS RECOMMENDED TO LEAVE IT CLOSE TO AVOID INTERFERENCE in the link, which can generate artifacts in the audio (a "robotic" sound).

Procedure for pairing:

1. Select with touch on the list a Bluetooth line.
2. Touch the option BLUETOOTH PAIRING. The UDX adapter Bluetooth will switch to mode *pairing* and the channel will display "pairing".
3. Turn on Bluetooth at the mobile and make a search for new Bluetooth devices. In the list must appear the item SOLIDYNE BTM641.
4. Connect to SOLIDYNE BTM641. The mobile is now paired and linked with UNIDEX adapter.
5. If more there are more than one Bluetooth line, rename the default Bluetooth name at the cell phone to identify each device (use a same name for the Bluetooth and the console's channel)

BLUETOOTH DEVICE'S NAME

On the mobile phone, the default name "Solidyne BTM641" can be edited by accessing the Bluetooth device settings. This configuration varies depending on the version of the mobile operating system.

By default, all UDX Bluetooth devices appear as SOLIDYNE BTM641. When using two more Bluetooth lines, it is a good idea to **rename the UDX devices on each phone to match the name assigned to the channel on the console**. In this way, on re-connection, each phone will be able to identify which channel (UDX Bluetooth device) it is pairing to.

If Bluetooth is turned off on the mobile, the TELCO screen and the OLED display will indicate "not liked".

The connection is restored by activating Bluetooth on the phone and choosing the Solidyne device again.

Telephone calls via Bluetooth manages in the same way as calls from POTS lines (see below). **The calls received through apps (watsapp, skype, etc.) must be answered directly from the mobile phone.**

5.8 WORKING WITH CALLS

Using UDX 2TEL-P adapter, the calls can be answered from a production office or by a telephone operator; and then be transferred to the UX24.

If you have a UDX 2TEL adapter, calls are answered in the Control Room directly from the console.

Each telephone line uses a channel in the console. Any channel can be configured to handle telephone lines or phones linked by Bluetooth.

5.8.1 Incoming call

1. When a call is received, **the CUE button will flash in blue** on the corresponding channel with the ring cadence. At the same time, a ring sound will be heard by CUE. On the TELCO screen the line indicates "RING".
2. The calling can be answered in two ways:
 - a) From the channel, pressing ON-AIR button.
 - b) From the TELCO screen, touching HOLD.

WARNING

When the call comes from an app (Whatsapp, Skype, Hangouts, etc.) it must be answered directly from the mobile phone.

When the call is answered, the line is taken (HOLD). The listener is not on the air and remains listening to the program signal.

3. To speak privately with the caller, press and hold the TLBK / CUE button. While the button is held down, the order microphone is sent to the telephone line. The OLED display indicates TLBK. In this mode the monitoring outputs of the Control Room are silenced.
When TLBK/CUE button releases, it returns to previous state (talkback function does not change the CUE state). With CUE on we listen to who is on the other side of the line, through the CUE circuit.
4. To air a calling, press ON AIR and raise the fader.
5. To hold the calling again, press ON AIR.
With Bluetooth, the call can be resumed from the mobile by turning off the hands-free mode; and returned to the console activating the hands-free.
6. To end the call, press and hold ON-AIR. Or touch HANG-UP on TELCO screen.

5.8.2 Make a call from console

1. Press the button TELCO on main screen.
2. Select a LINE from the list.
3. Touch on icon DIAL. A keyboard will pop up to dial.
4. Dial the number.
5. The audio from the line hears on CUE.
6. To speak privately with the line, press and hold the CUE button on the corresponding channel.

NOTE: ABOUT THE CALLS LEVEL

CALLINGS ON-AIR VOLUME: Do not mix calls with excessive level. The UDX-TEL adapter has a high but not absolute rejection. The audio sent to the line (the voice of the announcers), is not canceled 100% and returns through the hybrid, adding to the voices of the studio (the rejection setting optimizes this signal return). With adequate levels of work this effect is not noticeable; but if the hybrid is mixed at high levels the voices from the studio can "get dirty" (coloration).

Keep in mind that a telephone communication must not reach 0VU to match the loudness of the voices from the studio, with peaks at the same level. The bass, which carry the greatest energy and produce greater deviation in the indicators, are not present in the telephone line audio. However, for the ear the loudness is defined by the range of medium frequencies. So if you notice that the level meter "peaks lower" with a telephone line than the studio voices, this does not mean that "it is heard lower". On the other hand, the audio processor will be in charge of matching both signals.

Conclusion: do not be fooled by the level meter when mixing floor voices with phone calls.

5.9 AUDIO PROCESSORS

The available processors are fixed for each input. The processors that appears on a channel depends on which input is assigned to that channel.

The processors available for the inputs are following:

INPUT	PROCESSOR		
	EQ + Filters	Comp.+ Gate	De-esser
MIC	4 bands	yes	yes
UNIDEX	3 bands	yes	no
USB	3 bands	no	no
AES3	3 bands	no	no
BALANCED	3 bands	no	no

INPUT PROCESSING

The audio processing stages are fixedly implemented over each input. They are not "channel" processors, and can not be assigned to other channels, buses or outputs.

To access to the audio processors, press the button **PROCESS** at the main screen. This enables the function **SELECT** to choose a channel (for details please see 5.5 – *The function SELECT*).

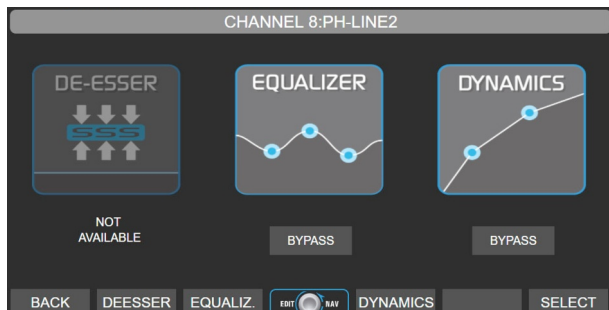

The screen **PROCESS** allows:

- Know which processors are available for the selected channel; and if they are active or bypassed.
- Enable/disable each processor by touching the **BY-PASS** option.

- Access the settings screen of a processor, by touching the on-screen icon, or the associated contextual button.

SELECT A CHANNEL:

- When the function **SELECT** is active, the buttons **CUE/SELECT** on the surface allows to select a channel.
- Turning the encoder navigates the 24 channels (hardware and virtuals). On screen the user see the processors status for each channel.

While the **SELECT** mode is on, the label zone appears in light blue for physical channels and violet for the virtuals.

NOTE

The **SELECT** mode cancels with any action on the **PROCESS** screen. The action will apply to the currently selected channel. **SELECT** mode can be re-called from any processor screen to choose another channel.

To navigate the parameters into a processing stage, use the encoder and tactile options (see at next).

5.9.1 PARAMETRIC EQUALIZER

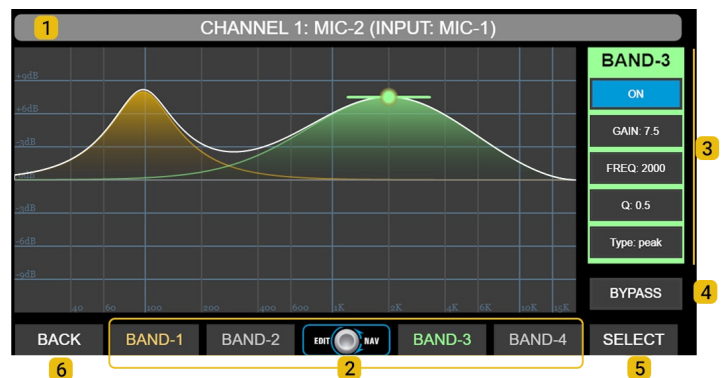

Navigation



TURN to choose an option.

The encoder navigates the options → **GAIN** → **FREQUENCY** → **Q** →

The controls **ON**, **TYPE** and **BY-PASS** can be switched only from touch-screen.

1 – CHANNEL and LABEL: Shows the channel # and label. For virtual channels, this area shows in violet.

2 – EQ BANDS: Band selection. The *control zone* at the right shows the values for the selected band. Each band identifies with different color. MIC-1 to MIC-4 have 4-bands parametric EQ. All other inputs have 3-bands EQ

3 – CONTROLS. Shows the parameters of an EQ band. The background color changes with the selected band. Equalizer settings can be saved in the current scene (see **SCENES**).

ON/OFF: Turn on/off the band. To switch the status, touch the option on screen.

GAIN: Set the gain in a range of ± 9 dB.

FREQ: Set the center frequency. Can work from 20Hz to 20KHz.

Q: EQ wide.

TYPE: EQ mode. To change between the options touch the item TYPE on screen. Band 1 can work as *peak*, *low-shelf* or *hi-pass filter (HPF)*. Bands 2 and 3 can be *peak*; *HPF* or *LPF*. Band 4 can work as *peak*; *hi-shelf* or *low-pass filter (LPF)*.

4 – BY-PASS: Disables the EQ. Bypass also appears into the PROCESS screen. To switch its status, touch the icon on screen..

5 – SELECT: Switchs on the mode SELECT, to choose a channel and make an action.

6 – BACK: Returns to previous screen.

5.9.1.1 LOW-PASS/HI-PASS FILTERS

The Band #1 can work as a 2nd order Hi-Pass Filter (12 dB/oct).

The Band #3 (Band #4 for the inputs MIC-1 to MIC-4) can work as a 2nd order Low-Pass Filter (12 dB/oct).

Band #2 (and Band #3 for the inputs MIC-1 to MIC-4) can work a HPF or LPF. Setting two bands with HPF/LPF at the same frequency, the attenuation slope will be 24 dB/oct.

5.9.2 DYNAMICS

The DYNAMIC stage has a noise gate and a wideband dynamic compressor. Processor settings can be saved in the current scene (see SCENES screen).

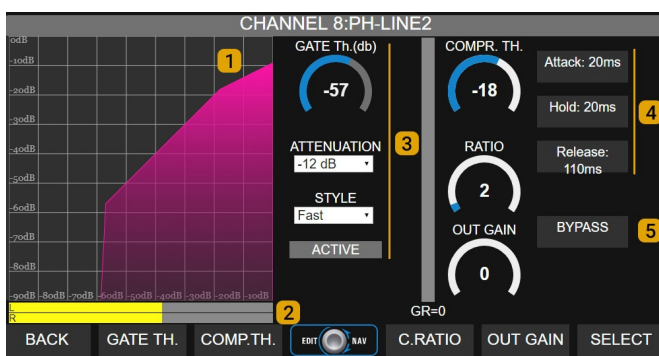

Navigation

TURN
Turn to choose an option:
→ GATE THRESHOLD → COMP THRESHOLD → RATIO → OUT GAIN → ATTACK → HOLD → RELEASE →

TOUCH
The functions **ATTENUATION**, **STYLE**, **BY-PASS** are change using the touch screen.

1 Transfer curve: Graphical representation of the dynamic processor input/output curve, including the gate and the compressor.

2 LEVEL: Peak level at the compressor input (dBfs).

3 GATE: noise gate.

GATE Threshold: Level in dB below which the gate closes.

ATTENUATION: Gain reduction applied to the signal when the gate acts.

STYLE: This option changes the recovery time between presetted values.

ACTIVE: This indication lights red when the gate closes.

4 COMPRESSOR: Standard controls for a compressor: threshold, ratio, attack and recovery times and reduction meter.

5 BYPASS: Disable the Dynamic processing.

5.9.3 DE-ESSER

Microphone inputs 1 to 4 have de-esser for sibilant reduction. The de-esser works as a mid-band compressor; attenuating a defined frequency range when the signal level is over the threshold value.

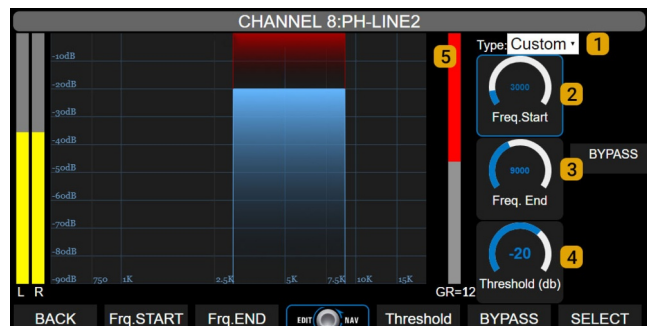

Navigation

TURN
The encoder navigates the options:
→ FREQ.START → FREQ.END → THRESHOLD →
To edit proceed as in the previous cases.

TOUCH
The features **TYPE** and **BY-PASS** are switched using the touch screen.

1 Type: Presets. Changes the behavior of de-esser.

2 Frequency start: Lower frequency for the working range. Usual values are between 4.5 to 5.5 KHz, according to the characteristics of the voice.

3 Frequency end: Upper frequency for the working range. Usual values are between 7 to 10 KHz, according to the characteristics of the voice.

- 4 Threshold:** Level in dB. When the signal level within the working range falls below the threshold, it is attenuated in a 15: 1 ratio
- 5 Gain reduction:** Shows the attenuation applied, in dB.

- needs the password to login (default: expert). The password can be changed only by logging with ADMIN profile.
- don't have access to advanced settings.
- has full access to the processors.
- can change the input gain, panning, label, input assignment and channel mode using the CHANNEL screen.

5.10 Scenes and user profiles

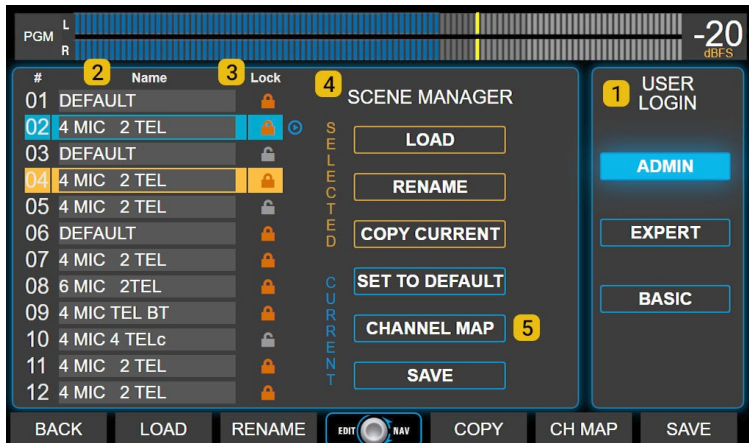

- can save changes to current scene, except for the protected scenes (which requires ADMIN profile).
- can create new scenes, even starting from a protected scene.

ADMIN USER: Has full access.

- It has password protection (default: admin). Allows you to change passwords from the SETTINGS screen.
- Can create protected scenes (read only) that can be used with all profiles but only can be changed by the ADMIN profile.

It is accessed from the main screen by pressing the SCENE button. It contains the options for SCENES management and USER profiles.

Navigation



The encoder navigates the list of scenes.



All options operates using the touch screen.

1 USERS: There are 3 user profiles with different access permissions. The restrictions for the on-board screen and the remote web interface are the same.

BASIC USER: Is the profile with more restrictions. Logged with this user, the operator:

- don't needs password to login.
- can't access to advanced settings.
- can load any scene, but can't save changes neither create new scenes.
- can see the settings and status of the processors, but cannot modify their parameters or turn on/off processors in the scene.
- can temporarily change basic channel options: GAIN; LABEL; PANNING; CHANNEL ACTIONS. Is not allowed to save changes to the scene.

EXPERT USER: This profile has a medium level of restriction. Logged with this user the operator:

When booting, UX24 loads a predefined user profile (default ADMIN). At startup, the password is never requested. You can change the boot user from the screen SETTINGS → USERS; and change passwords for ADMIN and EXPERT.

2 SCENES: It shows the list of 12 scenes that can be loaded directly by turning and pushing the encoder. The currently active scene is highlighted in light blue. The selected scene is highlighted in orange.

3 LOCK: The ADMIN user profile can create **protected scenes** (Lock): The scenes are indicated with a lock icon. EXPERT and BASIC profiles can load protected scenes, but cannot modify or delete them.

4 SCENE MANAGER: Shows two groups of actions: for the selected scene and for the current scene.

LOAD: Load the selected scene. Loading can be done by pressing the option on the screen; pressing the contextual button in the lower menu; or by turning and pressing the encoder. When loading a scene, a confirmation message will appear. If the action is not confirmed, the action is automatically canceled after 8 seconds. All user profiles can load any scene.

A scene can be loaded with one or more channels in the air. The channels remain on the air even if the input changes position (it will be updated). Audio will be dropped in case the previously aired input is not assigned to a channel in the new scene.

RENAME: Allows the user to rename the selected scene. If the console is being operated in the BASIC profile, this option is disabled.

COPY CURRENT: Copy the current scene over the selected scene. A message appears to confirm the action. If the action is not confirmed, it is automatically canceled after 8 seconds. If the console is being operated in the BASIC profile, this option is disabled.

SET TO DEFAULT: Resets the active scene to the factory default (see 4.2 Input/output default routing). If the console is being operated in the BASIC profile, this option is disabled.

SAVE: Saves the current settings, assignments, and processing settings to the active scene. The scene does not save the state of the ON-AIR and CUE buttons. If the console is being operated in the BASIC profile, this option is disabled. Protected scenes (LOCK) can only be modified by the ADMIN user.

5 CHANNEL MAP: It opens a window that shows the configuration of all the channels, and allows to re-order them in a very simple way.

SWAP 2 CH

Allows you to swap the order of two channels:

1. Touch the option **SWAP 2 CH**.
2. Select two channels from the list.

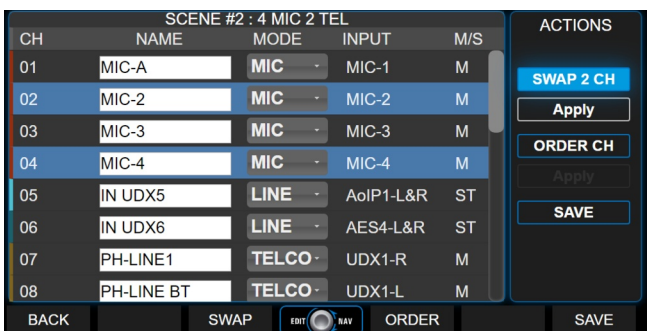

3. Touch **APPLY**. The channels will swap their positions.
4. Touch **SAVE** to save the changes to the scene.

ORDER CH

It allows to redefine the position of one or more channels.

1. Touch the **ORDER CH** option. A drop-down menu appears beside the names, that allows re-assign the position of each channel.

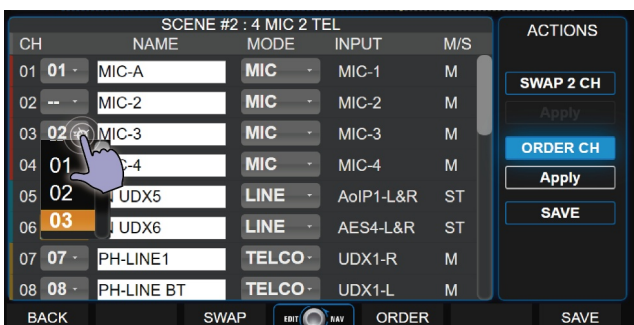

2. At the channel that wants to change, drop-down the menu by touching the arrow.
3. Choose a new position for the channel. It is possible to toggle several channels at the same instance.

WARNING

If you choose a channel position that is assigned to another input, the information on the destination channel will be overwritten when applying the changes.

4. Press **APPLY** to apply the changes temporarily. **APPLY** does not save changes to the scene. If you leave the scene, the changes are discarded.
5. For the changes to be stored permanently, press **SAVE**. The new channel arrangement is stored in the currently active scene.
6. To discard the changes, disable **ORDER CH** touching the option or press **BACK**.

5.11 VIRTUAL MIXER

UNIDEX UX24 manages 12 virtual channels in standard model, or 6 when is expanded with the extension UDX 6 which adds 6 hardware channels.

By pushing the *encoder* on the main screen, the user access to the **VIRTUAL MIXER** that allows to operate the virtual channels, in groups of six.



Push the encoder in the main screen to enter to the **VIRTUAL MIXER**.

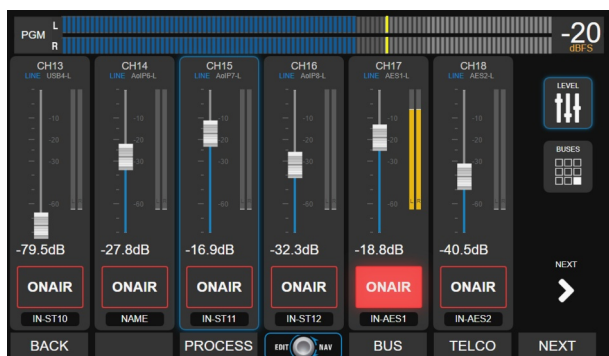

To allows the touch-screen operation, channel's controls are separated in two screens:



The screen **LEVEL** shows only the faders and the channel **ON** buttons.



The screen **BUSES** shows the assignment buttons **PGM**, **REC**, **AUX**, **VBUS** and the **CUE**.

SECTION 6 WEB REMOTE INTERFACE

All the features and configurations of the UX24 can be controlled remotely by connecting the console to the LAN, and accessing the IP address with a WEB browser.

NOTE

Remember that you can expand to 18 or 24 the number of hardware faders, to have all channels on the surface UX24.

6.1 Connecting to LAN

Step 1

Connect the Ethernet port REMOTE CONTROL to the LAN, using the factory-supplied Ethernet cable.

WARNING

UX24 has two ETHERNET ports: REMOTE CONTROL and STREAMING. Take care to avoid confuse the port.



By default, the console comes with a dynamic IP address (DHCP enabled). The router of local network will assign a free IP address. The assigned IP address is dynamic, which can change if the UX24 is restarted. A static IP address can be assigned from the system settings screen (SETTINGS → SYSTEM).

The assigned IP is shown on the main screen.

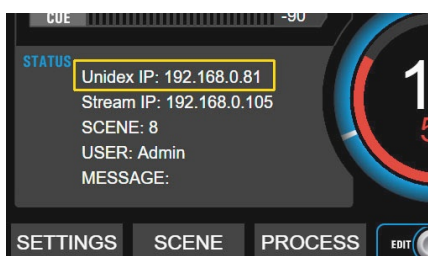

Step 2

From a computer connected to the same LAN (with cable or WiFi) open a web browser (we recommend Google Chrome) and enter the Unidex IP address .

The main screen will open, showing the level indicators and a main menu.

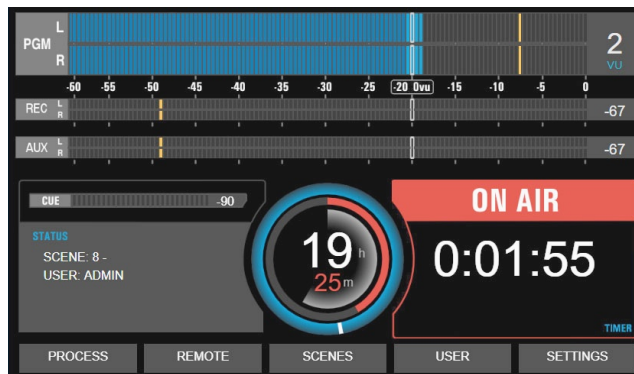

WEB screens contain the same options as the screen integrated in the UX24, although the layout and shape of the controls may differ. Only the screens with the greatest differences are detailed below.

6.2 WEB USER

Allows you to enter a user profile for the web interface, regardless of the user logged into the UX24 hardware. A dialog box will be displayed to enter the username, and then another to enter the password.

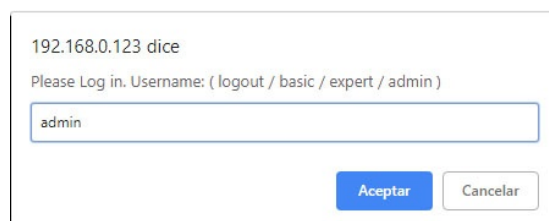

By default, the password is the same as the user's name. The option Logout leaves the console in the BASIC profile.

NOTE

Remember that three user profiles are available:

- ADMIN, with full access;
- EXPERT with partial access to some advanced features;
- BASIC, with restricted access.

By default UX24 starts loading the user profile ADMIN.

6.3 REMOTE CONTROL

The remote operation interface can control all channels of the console. It is designed for touch screens, as an auxiliary controller to operate virtual channels (from 13 to 24 on consoles without UX6 expansion modules); group communication channels (VoIP, cell phones, links, POTS) or manage auxiliary signals.

The monitoring panel allows to use the web interface as a full secondary mixer into auxiliary Studio.

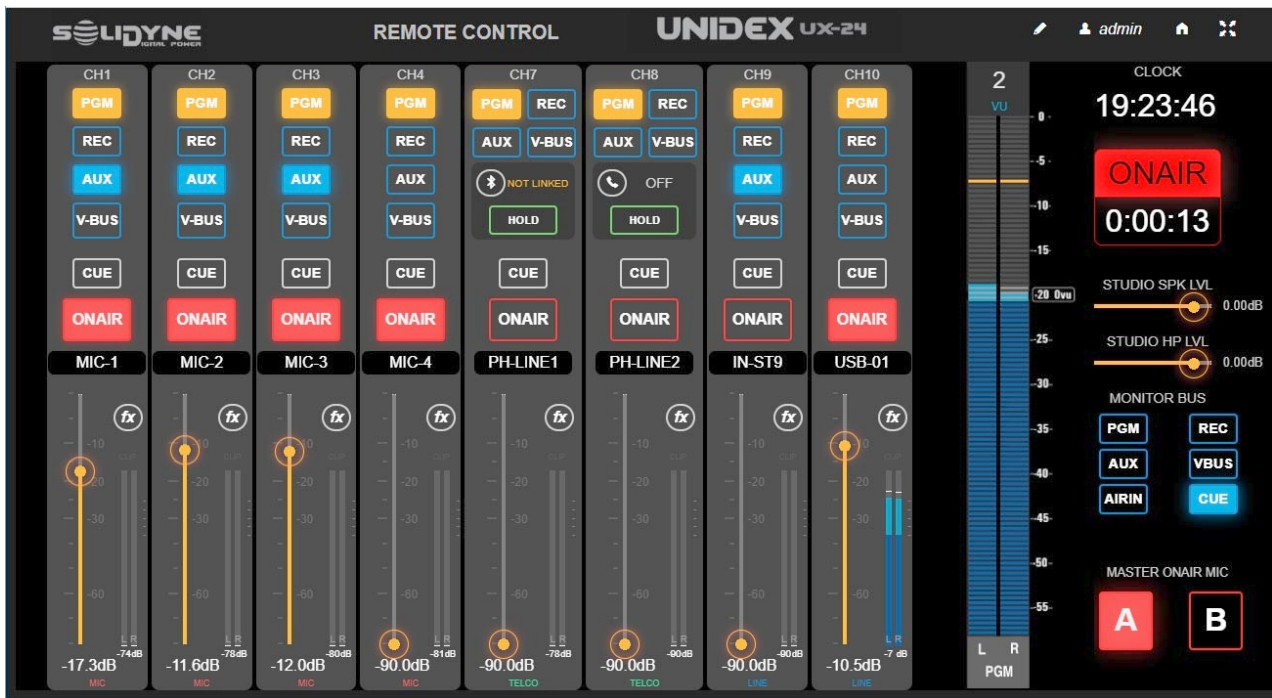

6.3.1 Settings

 Visible channels are set by pressing the "pencil" icon. This setting can only be modified with ADMIN user. The settings are stored in the current scene.

When you press the edit icon, a list of the 24 channels appears. The channels checked will be visible, always ordered from least to greatest.

CHANNEL	NAME	MODE	INPUT	VIEW
01	MIC-1	MIC	MIC-1	<input checked="" type="checkbox"/>
02	MIC-2	MIC	MIC-2	<input checked="" type="checkbox"/>
03	MIC-3	MIC	MIC-3	<input type="checkbox"/>
04	MIC-4	MIC	MIC-4	<input type="checkbox"/>
05	MIC-5 UDX5	MIC	UDX5-L	<input type="checkbox"/>
06	MIC-6 UDX5	MIC	UDX5-R	<input type="checkbox"/>
07	PH-LINE1	TELCO	UDX1-L	<input checked="" type="checkbox"/>

6.3.2 Mic and line channels

Each channel of the interface replicates the controls available on the UX24 hardware surface. Actions taken on the remote interface are reflected in the console.

BUSES: Assign the channel to a bus. The virtual bus VBUS do not have a hardware button. It is switched from the on-board touch screen (screen CHANNEL) or from remote Interface.

CUE: Turns on CUE on this channel. The audio listens through the CUE circuit of UX24.

ON AIR: ON/OFF the channel.

FADER: Channel level control. If the level is modified from the WEB interface, the console changes the level and shows the value on the OLED screen, which flashes indicating that the level of that channel was modified remotely.

The faders do not change their position, as they are not motorized. If the operator moves the fader in the console, the level returns to the fader value and the virtual fader is updated in the WEB interface.

6.3.3 TELCO channels

Telecommunications channels include, in addition to the controls already seen, a RING / HOLD button that allows you to answer an incoming call and put it on hold; and information about the status. Talk-back and dial functions must be done from the console surface.

6.4 PROCESS



From the PROCESS screen you can access the controls of the equalizer, the de-esser and the dynamic compressor. Its use is similar to that described for the on-board display (see 3.7 Audio processes).

1 The processors are inserted in each of the inputs. Choosing an input from drop-down menu, the available processes are displayed. You can also choose a CHANNEL from the CHANNEL menu, and the processors of the input assigned to that channel will be displayed.

2 In the case of parametric EQ, the ON / OFF buttons allow each band to be enabled or not; while boxes B1, B2, B3 and B4 allow you to select a band to display its controls. This method minimizes the amount of controls, facilitating use on touch screens.

3 The icons allow access to the different processes. Depending on the selected input, the available processors change. For details please see 5.9 - Audio processors

SECTION 7 DIAGRAMS AND TECH NOTES

Complementary documentation for download available on <http://www.solidynepro.com/unidex-V>

Diagrams

[GROUNDING: General recommendation for a radio station](http://solidynepro.com/descargas/productos/Grounding_recomendations.jpg)
http://solidynepro.com/descargas/productos/Grounding_recomendations.jpg

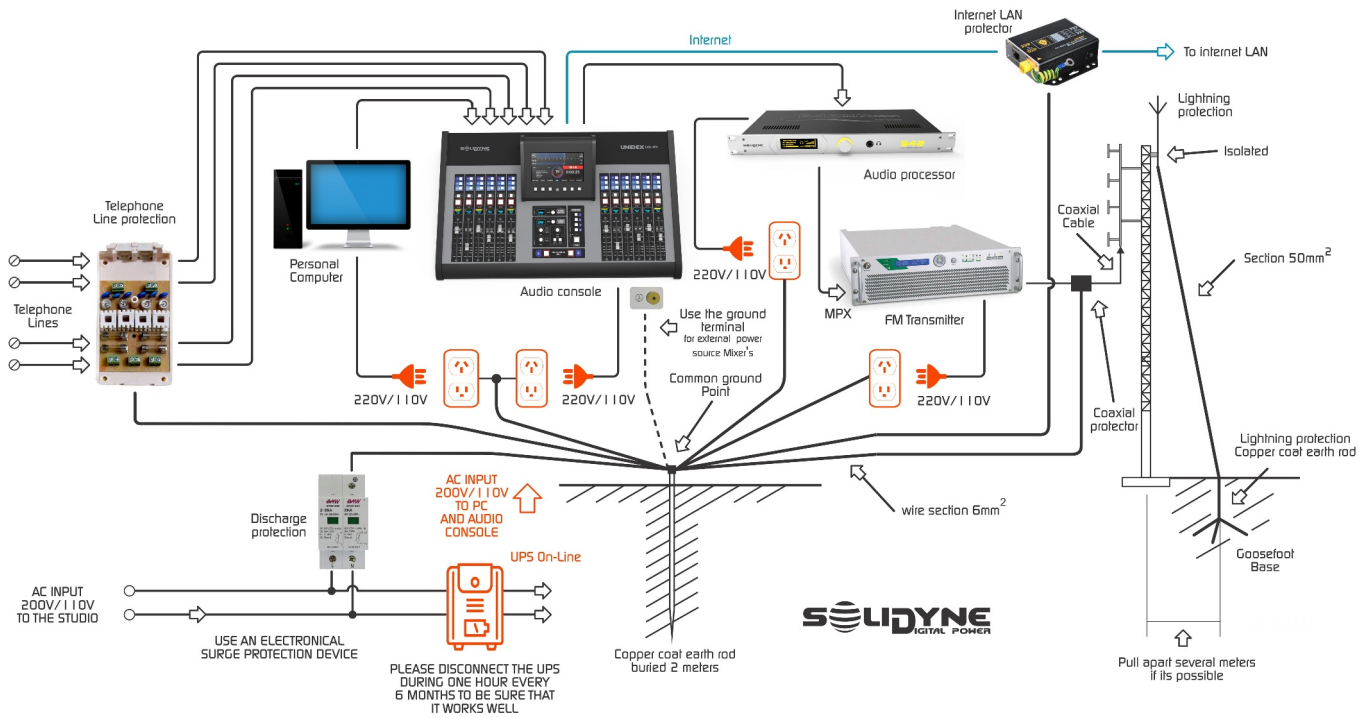

[Inputs and outputs map](http://solidynepro.com/descargas/productos/UX24_Quickguide_Inputs_and_Outputs_features.pdf)
http://solidynepro.com/descargas/productos/UX24_Quickguide_Inputs_and_Outputs_features.pdf

[UX24 scenes default routing](http://solidynepro.com/descargas/productos/UX24_Quickguide_Default_scenes_routing.pdf)
http://solidynepro.com/descargas/productos/UX24_Quickguide_Default_scenes_routing.pdf

Quick installation guides

[Adapter UDX 2MIC](http://solidynepro.com/descargas/productos/ENG-UDX2MIC_Quick_installation_guide.pdf)
http://solidynepro.com/descargas/productos/ENG-UDX2MIC_Quick_installation_guide.pdf

[Adapter UDX 2TEL y 2TEL-P](http://solidynepro.com/descargas/productos/ENG-UDX2TEL_Quick_installation_guide.pdf)
http://solidynepro.com/descargas/productos/ENG-UDX2TEL_Quick_installation_guide.pdf

[Adapter UDX TEL+BT](http://solidynepro.com/descargas/productos/ENG-UDXTEL+BT_Quick_Installation_Guide.pdf)
http://solidynepro.com/descargas/productos/ENG-UDXTEL+BT_Quick_Installation_Guide.pdf

[Adapter UDX USB](http://solidynepro.com/descargas/productos/UDXUSB_ENG_InstallationGuide.pdf)
http://solidynepro.com/descargas/productos/UDXUSB_ENG_InstallationGuide.pdf

Cables and kits for the installing

[Listing of cables and adapters \(PDF\)](http://www.solidynepro.com/descargas/folletos_ingles/RJ45cablesUDX-EngCast.pdf)
http://www.solidynepro.com/descargas/folletos_ingles/RJ45cablesUDX-EngCast.pdf

SECTION 8 TECH SPECS

Main Features

- 24 channels; 12 faders on console's surface, expandible to 24 with 6-faders modules Solidyne UX-6.
- 24 virtual faders can be operated from the on-board touch screen.
- Internal WEB pages remote interface (HTML5) to remote control via LAN.
- Inputs assignable to any of 24 channels.
- 12 user scenes (inputs routing, channel settings, audio processors settings)
- 7" touch screen on board 1024 x 600 pixels
- OLED display on channel (label, input level, fader level, special info)

Inputs (32)

- 4 MIC inputs 48V phantom powered
- 4 balanced stereo lines
- 4 AES3
- 4 stereo USB (4 USB playing devices in a computer)
- 16 UNIDEX mono balanced (8 stereo) supports up to additional 16 microphones. 8 Telco devices
- DSP audio processing on each input

Outputs (28)

- 2 PGM balanced stereo
- 4 balanced stereo (supports source assignation)
- 8 unbalanced (mix-minus)
- 4 AES3
- 4 stereo USB (4 recording devices in a computer)
- 2 streaming AoIP stereo (RTP, Icecast/shoutcast)
- 2 monitoring for Control Room (speakers and headphones)
- 2 monitoring for Studio (speakers and headphones + talkback)

GPIO, Intercom and auxiliary devices

- 2 "ON AIR" tally light (Studios A & B). 12 VCC, 250ma
- 4 GPI - general purpose inputs (active high 3.3 ~ 15 v)
- 8 GPO – general purpose outputs (7 open collector; + 24V @ 250 mA + 1 x 12V DC, 250 ma)
- 1 unbalanced stereo input for external tuner
- 1 tack-back input from studio (Studio Box connector)
- Built-in talk back microphone
- 4 Intertcom buttons can be assigned to outputs
- Independent Intercom PTT in all TELCO channels (TLKBK/CUE buttons).

Audio specifications

- 24 channels
- 4 mix stereo buses (PGM, REC, AUX with direct access from UX24 surface, VBUS assignable from screen.
- 1 bus PFL (CUE)
- 24bits SR@48 KHz
- DSP audio processing for all inputs. Fixed processors on each input. Parametric EQs of 3 & 4 bands. Noise gate. Compressor/limiter. De-esser (availability depends on the input type).
- Mix-minus sends and automatic talkback/intercom (TELCO)
- **LATENCY:** 1,2 mS (analog line to analog output) // 1,4 mS (MIC to output using EQ + Dynamics + De-Esser)

Digital inputs and outputs (AES3, USB, AoIP)

- RD: 120 dBA
- Freq. response: 20Hz-20KHz ± 0,1 dB
- THD: < 0,002 %

USB

- 1 USB 2.0 (4 stereo play/rec devices in a computer)
- ASIO 2.2 (supports simultaneous play running different softwares with ASIO and WDM)
- Supports VST HOSTS of 32-bit and 64-bit to run plug-ins in real time.
- Supports multi-client (more than one ASIO application running at the same time)
- Windows 10/8/7 (32 & 64 bits)

Analog inputs

- Input level: max: +26dBu, min: -24dBu , nominal: +4 dBu
- DR: 112 dBA
- Frequencies response: 20Hz-20Khz \pm 0,25 dB
- THD+N : 0,01 %

Mic inputs

- Input level: max: -24dBu, min: -75dBu , nominal: -50 dBu /150 ohm
- Noise: EIN @-50dBu input: -121 dBA
- Frequencies response: 20Hz-20Khz \pm 0,5 dB
- THD+N : 0,01 %
- Individual phantom power +48v

Analog outputs

- Flexible routing
- Balanced outputs
- Level: Nominal: +4 dBu Max: +24dBu
- DR: > 110 dBA
- Frequencies response: 20Hz-20Khz \pm 0,5 dB
- THD: typ 0,005%@1Khz

Dante AES67 (optional)

- The option DANTE manages 16 x 16 channels and supports any DANTE network up to 512 x 512 channels.
- The module AES67, replaces 4 stereo lines and 4 UNIDEX stereo inputs by 16 Dante AoIP inputs.
- AoIP outputs: PGM, REC, AUX, CR headphones, Studio headphones and 3 stereo assignable by the user.

Dimensions and weight

- Dimensions UX24 (12 faders):
 - wide: 730 mm
 - deep: 455 mm (550mm with the rear wing to hide cables)
 - height: 130 mm
- Packaging dimensions: 850 mm x 610 mm x 270 mm
- Weight: UX24= 8 Kg
 - Adapters UDX: 0,33 Kg each one
 - Kit cables RJ45: 4 Kg
 - With packaging UX24 + Cables= 15 Kg